



# Fire-resistance test on retrofit fire collars protecting a plasterboard wall penetrated by services

## Test Report

**Author:** Peter Gordon  
**Report number:** FSP 2126  
**Date:** 8 September 2020  
**Client:** IG6 Pty Ltd as trustee for the IG6 IP Trust

Commercial-in-confidence



This document is issued in accordance with NATA's accreditation requirements.

Accreditation No. 165 – Corporate Site No. 3625

Accredited for compliance with ISO/IEC 17025 - Testing



**Inquiries should be addressed to:**

|                              |                             |   |
|------------------------------|-----------------------------|---|
| Fire Testing and Assessments | Author                      | The Client                                  |
| NATA Registered Laboratory   | Infrastructure Technologies | IG6 Pty Ltd as trustee for the IG6 IP Trust |
| 14 Julius Avenue             | 14 Julius Avenue            | 3 Skirmish Court                            |
| North Ryde, NSW 2113         | North Ryde, NSW 2113        | Victoria Point QLD 4165                     |
| Telephone +61 2 9490 5444    | Telephone +61 2 9490 5500   | Telephone: 04 3390 5420                     |

**Report Status and Revision History:**

| VERSION    | STATUS           | DATE       | DISTRIBUTION   | ISSUE NUMBER |
|------------|------------------|------------|----------------|--------------|
| Revision A | Draft for review | 27/08/2020 | CSIRO / Client | FSP 2126     |
| Revision B | Final for issue  | 08/09/2020 | CSIRO / Client | FSP 2126     |

**Report Authorisation:**

| AUTHOR   | REVIEWED BY  | AUTHORISED BY  |
|--|--|--|
| Peter Gordon   | Glenn Williams   | Brett Roddy  |
|  |  |  |
| 8 September 2020   | 8 September 2020   | 8 September 2020   |

## Use of this Report

### **Use of Reports – Testing**

*This report is subject to binding obligations under which it was prepared. In particular, the Report must not be used:*

- *as a means of endorsement; or*
- *in a company prospectus or notification to a Stock Exchange document for capital raising, without the prior written consent of CSIRO.*

*The Report may be published verbatim and in full, provided that a statement is included on the publication that it is a copy of the Report issued by CSIRO.*

*Excerpts of the Report may not be published.*

### **Use of Reports – Consultancy**

*This report is subject to binding obligations under which it was prepared. In particular, the Report may only be used for the following purposes:*

- *the information in the Report may be used by the party that commissioned the Report for its internal business operations (but not licensing to third parties);*
- *the report may be copied for distribution within the organisation that commissioned the Report;*
- *copies of the Report (or extracts of the Report) may be distributed to contractors and agents of the organisation that commissioned the Report who have a need for the Report for its internal business operations. Any extracts of the Report distributed for this purpose must clearly note that the extract is part of a larger Report held by the organisation that commissioned the Report and which has been prepared by CSIRO.*

*The name, trade mark or logo of the CSIRO must not be used without the prior written consent of CSIRO.*

*The Report must not be used as a means of endorsement without the prior written consent of CSIRO.*

## Copyright and disclaimer

© 2020 CSIRO To the extent permitted by law, all rights are reserved and no part of this publication covered by copyright may be reproduced or copied in any form or by any means except with the written permission of CSIRO.

## Important disclaimer

CSIRO advises that the information contained in this publication comprises general statements based on scientific research. The reader is advised and needs to be aware that such information may be incomplete or unable to be used in any specific situation. No reliance or actions must therefore be made on that information without seeking prior expert professional, scientific and technical advice. To the extent permitted by law, CSIRO (including its employees and consultants) excludes all liability to any person for any consequences, including but not limited to all losses, damages, costs, expenses and any other compensation, arising directly or indirectly from using this publication (in part or in whole) and any information or material contained in it.

# Contents

|     |  |    |
|-----|--|----|
| 1   | Introduction .....   | 5  |
| 1.1 | Identification of specimen .....   | 5  |
| 1.2 | Sponsor .....  | 5  |
| 1.3 | Manufacturer .....   | 5  |
| 1.4 | Test standard .....  | 5  |
| 1.5 | Reference standard.....  | 5  |
| 1.6 | Test number.....   | 5  |
| 1.7 | Test date .....  | 6  |
| 2   | Description of specimen .....  | 6  |
| 2.1 | General.....   | 6  |
| 2.2 | Dimensions .....   | 9  |
| 2.3 | Orientation.....   | 9  |
| 2.4 | Conditioning.....  | 9  |
| 2.5 | Selection, construction and installation of the specimen and the supporting construction | 9  |
| 3   | Documentation .....  | 10 |
| 4   | Equipment.....   | 10 |
| 4.1 | Furnace .....  | 10 |
| 4.2 | Temperature .....  | 10 |
| 4.3 | Measurement system .....   | 11 |
| 5   | Ambient temperature .....  | 11 |
| 6   | Departure from standard .....  | 11 |
| 7   | Termination of test .....  | 11 |
| 8   | Test results .....   | 11 |
| 8.1 | Critical observations .....  | 11 |
| 8.2 | Furnace temperature.....   | 13 |
| 8.3 | Furnace severity.....  | 13 |
| 8.4 | Specimen temperature.....  | 13 |
| 8.5 | Performance .....  | 13 |
| 9   | Fire-resistance level (FRL) .....  | 15 |
| 10  | Field of direct application of test results .....  | 15 |
| 11  | Tested by.....   | 15 |
|     | Appendices .....   | 16 |
|     | Appendix A – Measurement location .....  | 16 |
|     | Appendix B – Photographs.....  | 18 |
|     | Appendix C – Furnace Temperature .....   | 26 |
|     | Appendix D – Layout and installation drawings.....                                       | 34 |
|     | Appendix E – Specimen Drawings .....   | 41 |
|     | Appendix F – Certificate(s) of Test.....   | 42 |
|     | References.....  | 48 |

# Fire-resistance test on retrofit fire collars protecting a plasterboard wall penetrated by services

## Sponsored Investigation No. FSP 2126

### 1 Introduction

#### 1.1 Identification of specimen

The sponsor identified the specimen as SNAP Multi Service Retrofit MS70R fire collars protecting a plasterboard wall penetrated by six services.

#### 1.2 Sponsor

IG6 Pty Ltd as trustee for the IG6 IP Trust  
3 Skirmish Court  
Victoria Point QLD 4165  
Australia

#### 1.3 Manufacturer

Snap Fire Systems Pty Ltd  
Building A, 1343 Wynnum Road  
Tingalpa QLD 4173  
Australia

#### 1.4 Test standard

Australian Standard 1530, Methods for fire tests on building materials, components and structures, Part 4-2014, Fire-resistance tests for elements of construction.

Section 10: Service penetrations and control joints

#### 1.5 Reference standard

Australian Standard 4072, Components for the protection of openings in fire-resistant separating elements, Part 1 - 2005, Service penetrations and control joints.

#### 1.6 Test number

CSIRO Reference test number FS 5000/4545

## 1.7 Test date

The fire-resistance test was conducted on 6 July 2020.

# 2 Description of specimen

## 2.1 General

The specimen comprised an 1150-mm x 1150-mm x 116-mm thick plasterboard wall system penetrated by six (6) services protected by retro-fitted Snap Fire Systems fire collars

The plasterboard wall was constructed in accordance with Boral Firestop system SB120.1 with an established fire resistance level (FRL) of -/120/120 as detailed in the document titled “Plasterboard Fire and Acoustic Systems Australia”, revision UB1231-SYS 12/18, by USG Boral Building Products Pty Ltd. Construction comprised a 64-mm x 0.55-mm steel studs installed at nominally 600-mm centres, lined on each side with two layers of 13-mm thick Boral Firestop plasterboard sheets. The plasterboard sheeting was screw fixed to the steel studs using 6g 32-mm and 45-mm plasterboard screws at nominally 200-mm centres. The wall cavity was filled with a single layer 50-mm thick Acoustigard 11.

For the purpose of the test, the penetrations are referenced as Specimen 1, 2, 3, 4, 5 and 6. Documents containing a complete description of each specimen were supplied by the sponsor and are retained on file.

The pipes and electric cables used in the test are stated to be manufactured in accordance with:

- AS 1432:2004 Copper tubes for plumbing, gas fitting and drainage applications;
- AS/NZS 1477:2017 PVC pipes and fittings for pressure applications and
- AS/NZS 5000.1:2005 (R2017): Electric cables - Polymeric insulated - For working voltages up to and including 0.6/1 (1.2) kV

### Specimen 1 - SNAP MS70R Multi Services Retrofit fire collars protecting a DN25B copper tube with 19-mm F/R lagging and a thermoplastic-sheathed cable (TPS).

The SNAP Multi Service Retrofit MS70R fire collar comprised a 0.75-mm thick steel casing with a 69-mm inner diameter and a 0.95-mm thick steel base flange with a 162-mm diameter. The 95 mm high collar casing incorporated a 4-mm thick x 90-mm wide x 250-mm long soft Intumesh intumescent wrap lined within the internal circumference of the collar casing. The closing mechanism comprised three stainless steel springs, a nylon fuse link and a 258-mm long x 88-mm wide 316 stainless steel mesh located around the intumescent strip, as shown in drawing titled “SNAP 70 Multi Service Retro”, dated 23 September 2019, by Snap Fire Systems Pty Ltd. One collar was fixed to each side of the wall in a back-to-back configuration through the collar mounting brackets using three M4 expandable steel anchors.

The penetrating service comprised a 1-inch outside diameter copper pipe with a wall thickness of 1.1-mm, lagged with 19-mm thick E-flex insulation and a 3-core 2.5-mm<sup>2</sup> TPS cable. The lagged pipe and cable were fitted through the collar’s sleeve and penetrated the wall through a 64-mm diameter cut-out hole as shown in drawing titled “Specimen #1 1inch Copper Tube with 19mm F/R Lagging, 3C TPS Cable & MS70R Collar”, dated 11 June 2020, by Snap Fire Systems Pty Ltd.

The lagged pipe and cable projected horizontally, 550-mm away from the unexposed face of the wall and approximately 500-mm into the furnace chamber and were supported at nominally 500-mm from the unexposed face of the plasterboard wall. The 1-inch copper pipe was left open on the unexposed end and crimped closed on the exposed end.

Specimen 2 - SNAP MS70R Multi Services Retrofit fire collar protecting a nominal 50-mm PVC conduit incorporating two 6-mm<sup>2</sup> 3C+E and two 16-mm<sup>2</sup> 3C+E power cables.

The SNAP Multi Service Retrofit MS70R fire collar comprised a 0.75-mm thick steel casing with a 69-mm inner diameter and a 0.95-mm thick steel base flange with a 162-mm diameter. The 95-mm high collar casing incorporated a 4-mm thick x 90-mm wide x 250-mm long soft Intumesh intumescent wrap lined within the internal circumference of the collar casing. The closing mechanism comprised three stainless steel springs, a nylon fuse link and a 258-mm long x 88-mm wide 316 stainless steel mesh located around the intumescent strip, as shown in drawing titled "SNAP 70 Multi Service Retro", dated 23 September 2019, by Snap Fire Systems Pty Ltd. One collar was fixed to each side of the wall in a back-to-back configuration through the collar mounting brackets using three M4 expandable steel anchors.

The penetrating service comprised a 60-mm outside diameter Telstra PVC conduit with a wall thickness of 2.71-mm containing two 6-mm<sup>2</sup> 3-core+E power cables and two 16-mm<sup>2</sup> 3-core+E power cables running through the conduit. All the power cables were manufactured by General Cables. The PVC conduit and four power cables were fitted through the collar's sleeve and penetrated the wall through a 64-mm diameter cut-out hole as shown in drawing titled "Specimen #2 50 PVC Conduit with 16mm<sup>2</sup> 3C+E & 6mm<sup>2</sup> 3C+E Power Cables & MS70R Collar", dated 11 June 2020, by Snap Fire Systems Pty Ltd. The conduit and cables projected horizontally, 2000-mm away from the unexposed face of the wall and approximately 500-mm into the furnace chamber. The conduit was supported at nominally 500-mm and 1500-mm from the unexposed face of the plasterboard wall. The conduit was open at the unexposed end and plugged with ceramic fibre (Superwool) on the exposed end.

Specimen 3 - SNAP MS70R Multi Services Retrofit fire collars protecting a bundle of 20 Category 5e network cables.

The SNAP Multi Service Retrofit MS70R fire collar comprised a 0.75-mm thick steel casing with a 69-mm inner diameter and a 0.95-mm thick steel base flange with a 162-mm diameter. The 95--mm high collar casing incorporated a 4-mm thick x 90-mm wide x 250-mm long soft Intumesh intumescent wrap lined within the internal circumference of the collar casing. The closing mechanism comprised three stainless steel springs, a nylon fuse link and a 258-mm long x 88-mm wide 316 stainless steel mesh located around the intumescent strip, as shown in drawing titled "SNAP 70 Multi Service Retro", dated 23 September 2019, by Snap Fire Systems Pty Ltd. One collar was fixed to each side of the wall in a back-to-back configuration through the collar mounting brackets using three M4 expandable steel anchors.

The penetrating service comprised a bundle of 20 ADC Krone Category 5e network cables. The cables were fitted through the collar's sleeve and penetrated the wall through a 70-mm diameter cut-out hole as shown in drawing titled "Specimen #3 20% Full of Cat5e Cables & MS70R Collar", dated 11 June 2020, by Snap Fire Systems Pty Ltd.

The cables projected horizontally 550-mm away from the unexposed face of the wall and approximately 500-mm into the furnace chamber. The cables were supported at nominally 500-mm from the unexposed face of the plasterboard wall.

Specimen 4 - SNAP MS70R Multi Services Retrofit fire collars protecting a bundle of 100 Category 5e network cables.

The SNAP Multi Service Retrofit MS70R fire collar comprised a 0.75-mm thick steel casing with a 69-mm inner diameter and a 0.95-mm thick steel base flange with a 162-mm diameter. The 95-mm high collar casing incorporated a 4-mm thick x 90-mm wide x 250-mm long soft Intumesh intumescent wrap lined within the internal circumference of the collar casing. The closing mechanism comprised three stainless steel springs, a nylon fuse link and a 258-mm long x 88-mm wide 316 stainless steel mesh located around the intumescent strip, as shown in drawing titled "SNAP 70 Multi Service Retro", dated 23 September 2019, by Snap Fire Systems Pty Ltd. One collar was fixed to each side of the wall in a back-to-back configuration through the collar mounting brackets using three M4 expandable steel anchors.

The penetrating service comprised a bundle of 100 ADC Krone Category 5e network cables. The cables were fitted through the collar's sleeve and penetrated the wall through a 70-mm diameter cut-out hole as shown in drawing titled "Specimen #4 100% Full of Cat5e Cables & MS70R Collar", dated 11 June 2020, by Snap Fire Systems Pty Ltd.

The cables projected horizontally, 550-mm away from the unexposed face of the wall and approximately 500-mm into the furnace chamber. The cables were supported at nominally 500-mm from the unexposed face of the plasterboard wall.

Specimen 5 - SNAP MS70R Multi Services Retrofit fire collar protecting a ¾-in and a ⅜-in Pair Coil, a nominal 25-mm PN12 PVC-U pipe and a 2.5-mm<sup>2</sup> 3C+E power cable.

The SNAP Multi Service Retrofit MS70R fire collar comprised a 0.75-mm thick steel casing with a 69-mm inner diameter and a 0.95-mm thick steel base flange with a 162-mm diameter. The 95-mm high collar casing incorporated a 4-mm thick x 90-mm wide x 250-mm long soft Intumesh intumescent wrap lined within the internal circumference of the collar casing. The closing mechanism comprised three stainless steel springs, a nylon fuse link and a 258-mm long x 88-mm wide 316 stainless steel mesh located around the intumescent strip, as shown in drawing titled "SNAP 70 Multi Service Retro", dated 23 September 2019, by Snap Fire Systems Pty Ltd. One collar was fixed to each side of the wall in a back-to-back configuration through the collar mounting brackets using three M4 expandable steel anchors.

The penetrating service comprised a ¾-in and a ⅜-in pair coil, a PN12 PVC-U pipe and a 2.5-mm<sup>2</sup> 3C+E power cable. The Ardent pair coil comprised two copper pipes having outside diameters of 9.82-mm, 19.05-mm and wall thicknesses of 0.81-mm and 1.14-mm respectively with both pipes covered with a 10-mm thick crosslinked non fire rated PE foam lagging. The Pipemaster PN12 PVC-U pipe had an outside diameter of 26.82-mm and wall thickness of 1.6-mm. The Electra Cables comprised a 2.5-mm<sup>2</sup> 3C+E power cable with an outside diameter of 11.1-mm. The pair coil, PVC pipe and power cable were fitted through the collar's sleeve and penetrated the wall through a 64-mm diameter cut-out hole as shown in drawing titled "Specimen #5 ¾-in & ⅜-in Insulated Copper Pair Coil, 25-mm Pressure PVC, 2.5mm<sup>2</sup> 3C+E Cable & MS70R", dated 11 June 2020", provided by Snap Fire Systems Pty Ltd. The annular gap around the pair coil, PVC pipe, cable and plasterboard on both sides of the wall was filled with a 10-mm deep bead of H.B Fullers Firesound sealant.

The 25-mm pressure PVC conduit projected horizontally 2000-mm away from the unexposed face of the wall and approximately 500-mm into the furnace chamber and was supported at nominally 500-mm and 1500-mm from the unexposed face of the wall. The ¾-in and ⅜-in copper lagged pair coil pipes and the power cable projected horizontally 550-mm away from the unexposed face of the wall and approximately 500-mm into the furnace chamber and were supported at nominally 500-mm from the unexposed face of the wall. The 25-mm pressure PVC pipe was open on the unexposed end and capped with a ceramic fibre (Superwool) plug on the exposed end. The ¾-in and a ⅜-in copper pipes were left open on the unexposed face and crimped closed on the exposed end.



## Specimen 6 - SNAP MS70R Multi Services Retrofit fire collars protecting a bundle of six 16-mm<sup>2</sup> 3C+E and three 6-mm<sup>2</sup> 3C+E power cables.

The SNAP Multi Service Retrofit MS70R fire collar comprised a 0.75-mm thick steel casing with a 69-mm inner diameter and a 0.95-mm thick steel base flange with a 162-mm diameter. The 95-mm high collar casing incorporated a 4-mm thick x 90-mm wide x 250-mm long soft Intumesh intumescent wrap lined within the internal circumference of the collar casing. The closing mechanism comprised three stainless steel springs, a nylon fuse link and a 258-mm long x 88-mm wide 316 stainless steel mesh located around the intumescent strip, as shown in drawing titled “SNAP 70 Multi Service Retro”, dated 23 September 2019, by Snap Fire Systems Pty Ltd. One collar was fixed to each side of the wall in a back-to-back configuration through the collar mounting brackets using three M4 expandable steel anchors.

The penetrating service comprised a bundle of six 16-mm<sup>2</sup> 3-core+E power cables and three 6-mm<sup>2</sup> 3-core+E power cables. All the cables were manufactured by General Cables. The cables were fitted through the collar’s sleeve and penetrated the wall through a 70-mm diameter cut-out hole as shown in drawing titled “Specimen #6 16mm<sup>2</sup> 3C+E & 6mm<sup>2</sup> 3C+E Power Cables & MS70R Collar”, dated 11 June 2020, by Snap Fire Systems Pty Ltd.

The annular gap around the cables and plasterboard on both sides of the wall was filled with a 10-mm deep bead of H.B Fullers Firesound sealant. The cables projected horizontally 550-mm away from the unexposed face of the wall and approximately 500-mm into the furnace chamber. The cables were supported at nominally 500-mm from the unexposed face of the plasterboard wall.

## 2.2 Dimensions

The wall specimen was nominally 1150-mm wide x 1150-mm high x 116-mm thick.

## 2.3 Orientation

The plasterboard wall was placed vertically against the furnace chamber and subjected to fire exposure from one side only.

## 2.4 Conditioning

The specimen was delivered on 1 July 2020 and stored under standard laboratory atmospheric conditions until the test date.

## 2.5 Selection, construction and installation of the specimen and the supporting construction

The supporting wall construction and specimen installation was organised by the sponsor. CSIRO was not involved in the selection of the materials.

## 3 Documentation

The following documents were supplied or referenced by the sponsor as a complete description of the specimen and should be read in conjunction with this report:

- Documents titled “Plasterboard Fire and Acoustic Systems Australia”, revision UB1231-SYS 12/18, by USG Boral Building Products Pty Ltd.
- Drawing titled “Test Wall W-20-G Layout”, dated 10 June 2020, by Snap Fire Systems Pty Ltd.
- Drawing titled “Specimen #1 1inch Copper Tube with 19mm F/R Lagging, 3C TPS Cable & MS70R Collar”, dated 11 June 2020, by Snap Fire Systems Pty Ltd.
- Drawing titled “Specimen #2 50 PVC Conduit with 16mm<sup>2</sup> 3C+E & 6mm<sup>2</sup> 3C+E Power Cables & MS70R Collar”, dated 11 June 2020, by Snap Fire Systems Pty Ltd.
- Drawing titled “Specimen #3 20% Full of Cat5e Cables & MS70R Collar”, dated 11 June 2020, provided by Snap Fire Systems Pty Ltd.
- Drawing titled “Specimen #4 100% Full of Cat5e Cables & MS70R Collar”, dated 11 June 2020, provided by Snap Fire Systems Pty Ltd.
- Drawing titled “Specimen #5 ¾-in & ⅜-in Insulated Copper Pair Coil, 25-mm Pressure PVC, 2.5mm<sup>2</sup> 3C+E Cable & MS70R”, dated 11 June 2020”, provided by Snap Fire Systems Pty Ltd.
- Drawing titled “Specimen #6 16mm<sup>2</sup> 3C+E & 6mm<sup>2</sup> 3C+E Power Cables & MS70R Collar”, dated 11 June 2020, provided by Snap Fire Systems Pty Ltd.
- Drawing titled “SNAP 70 Multi Service Retro”, dated 23 September 2019, by Snap Fire Systems Pty Ltd.

## 4 Equipment

### 4.1 Furnace

The furnace had a nominal opening of 1000-mm x 1000-mm for attachment of vertical or horizontal specimens.

The furnace was lined with refractory bricks and materials with the thermal properties as specified in AS 1530.4-2014 and was heated by combustion of a mixture of natural gas and air.

### 4.2 Temperature

The temperature in the furnace chamber was measured by four type K, 3-mm diameter, and 310 stainless steel Mineral Insulated Metal Sheathed (MIMS) thermocouples. Each thermocouple was housed in high-nickel steel tubes opened at the exposed end.

The temperatures of the specimen were measured by glass-fibre insulated and sheathed K-type thermocouples with a wire diameter of 0.5-mm.

Location of the thermocouples on the unexposed face of the specimen are described in Appendix A.

### 4.3 Measurement system

The primary measurement system comprised a multiple-channel data logger, scanning at one minute intervals during the test.

## 5 Ambient temperature

The temperature of the test area was 15°C at the commencement of the test.

## 6 Departure from standard

There were no departures from the requirements of AS 1530.4-2014.

## 7 Termination of test

The test was terminated at 181 minutes by the agreement with the sponsor.

## 8 Test results

### 8.1 Critical observations

The following observations were made during the fire-resistance test:

| Time         | Observation   |
|--------------|---|
| 1 minutes -  | Smoke is being emitted between the collar and the pipe of Specimens 3 and 4. Smoke has begun fluing from the end of the pipe of Specimen 2. Cotton pad test was applied between the cables and the collar at the base of Specimen 3 – no ignition noted at this time. |
| 2 minutes -  | Smoke is being emitted between the cables and the collar of Specimen 6.   |
| 4 minutes -  | Smoke has begun fluing from the end of the PVC pipe of Specimen 5. The bundle of cables of Specimen 3 has been pushed out away from the wall approximately 30-mm.   |
| 6 minutes -  | Smoke has ceased fluing from Specimens 2, 3, 4 and 5 and only light smoke emitted from the PVC pipe of Specimen 1.  |
| 8 minutes -  | Smoke has ceased fluing from the collars of Specimen 1 and 6.   |
| 11 minutes - | Light smoke has resumed fluing between the collar and the pipe of Specimen 3. Smoke has ceased fluing from Specimen 1.  |
| 16 minutes - | The E-Flex insulation around the pipe of Specimen 1 has swollen along the length of the pipe.   |
| 27 minutes - | Light smoke is being emitted between collar and the services of Specimen 5.   |
| 31 minutes - | The E-Flex insulation around the pipe of Specimen 1 continues to swell with a split in the lagging adjacent to thermocouples #6 and #7.   |
| 34 minutes - | Light smoke has resumed fluing between the collar and the pipe of Specimens 5 and 6.  |

- 36 minutes - Light smoke has resumed fluing from the PVC pipe of Specimen 2.
- 40 minutes - The orange sheath on the cables – top right of Specimen 6 adjacent to the collar has begun to discolour (Photograph 8).
- 45 minutes - The lagging of the pair coil has begun to melt and shrink with thermocouple #32 on the ¾ lagging no longer in full contact.
- 62 minutes - The orange sheath on the 16-mm<sup>2</sup> cable – top right of Specimen 6 adjacent to the collar has begun to split (Photograph 10).
- 66 minutes - The blue sheath at the top of cable bundles and of Specimens 3 and 4 have started to discolour, with the adjacent collars having smoke stains.
- 75 minutes - Smoke staining is visible on the plasterboard wall above Specimen 5 (Photograph 11).
- 82 minutes - The level of smoke being emitted from all the specimens has increased.
- 90 minutes - The lagging of the pair coil has continued to melt and shrink with thermocouple #31 on the ¾ lagging and #32 on the ¾ lagging no longer in full contact. Roving thermocouple applied to on the lagging of ¾ copper pipe, 25-mm from the collar with a temperature of 179° C noted.
- 97 minutes - Roving thermocouple applied to on the lagging of ¾ copper pipe, 25-mm from the collar with a temperature of 114° C noted.
- 102 minutes - Roving thermocouple applied to the 16-mm<sup>2</sup> cable 25-mm from the collar with a temperature of 180° C noted.
- 114 minutes - Roving thermocouple applied to the 16-mm<sup>2</sup> cable 25-mm from the collar with a temperature of 178° C noted.
- 118 minutes - Roving thermocouple applied to the 16-mm<sup>2</sup> cable 25-mm from the collar with a temperature of 189° C noted.
- 122 minutes - Thermocouple #32 manually reapplied to the ¾ lagged pair coil with a temperature of 153° C noted.
- 123 minutes - Insulation Failure of Specimen 1 – maximum temperature rise of 180K is exceeded on the top of the E-Flex pipe lagging 25-mm from the collar.
- 135 minutes - Roving thermocouple applied close to thermocouple #7 where insulation has not split 25-mm from the collar with a temperature of 152° C noted. Thermocouple #6 is now measuring over the split lagging.
- 138 minutes - The nylon fuse inside the collar on the unexposed face of Specimen 3 has been released, however, the two lower nylon fuses remain attached to the casing.
- 146 minutes - Insulation Failure of Specimen 6 – maximum temperature rise of 180K is exceeded on the 16-mm<sup>2</sup> power cable 25-mm from the above the collar. A loud clicking noise was heard from Specimen 6, the nylon fuse inside the collar on the unexposed face has been released, however, the two lower nylon fuses remain attached to the casing.
- 149 minutes - Black intumescent material has begun filling the collar of Specimen 6, inside the collar on the unexposed face.
- 151 minutes - Insulation Failure of Specimen 2 – maximum temperature rise of 180K is exceeded on the top left side of collar, 25-mm from wall.
- 166 minutes - Insulation Failure of Specimen 4 – maximum temperature rise of 180K is exceeded on the plasterboard wall 25-mm above the collar.
- 175 minutes - Insulation Failure of Specimen 5 – maximum temperature rise of 180K is exceeded on the plasterboard wall 25-mm above the collar. The plasterboard wall continues to char around specimens.
- 179 minutes - A dark liquid is dropping down the wall from Specimen 4. The plasterboard wall around Specimens 2 and 4 has begun to discolour and char.
- 180 minutes - Insulation Failure of Specimen 3 – maximum temperature rise of 180K is exceeded on the plasterboard wall 25-mm above the collar.
- 181 minutes - Test terminated.

## 8.2 Furnace temperature

Figure 1 shows the standard curves of temperature versus time for heating the furnace chamber and the actual curves of average and maximum temperature versus time recorded during the heating period.

## 8.3 Furnace severity

Figure 2 shows the curve of furnace severity versus time during the heating period.

## 8.4 Specimen temperature

Figure 3 shows the curve of temperature versus time associated with Specimen 1.

Figure 4 shows the curve of temperature versus time associated with Specimen 2.

Figure 5 shows the curve of temperature versus time associated with Specimen 3.

Figure 6 shows the curve of temperature versus time associated with Specimen 4.

Figure 7 shows the curve of temperature versus time associated with Specimen 5.

Figure 8 shows the curve of temperature versus time associated with Specimen 6.

## 8.5 Performance

Performance observed in respect of the following AS 1530.4-2014 criteria:

Specimen 1 - SNAP MS70R Multi Services Retrofit fire collars protecting a DN25B copper tube with 19-mm F/R lagging and a thermoplastic-sheathed cable (TPS)

|                     |   |                           |
|---------------------|---|---------------------------|
| Structural adequacy | - | not applicable            |
| Integrity           | - | no failure at 181 minutes |
| Insulation          | - | 123 minutes               |

Specimen 2 - SNAP MS70R Multi Services Retrofit fire collar protecting a nominal 50-mm PVC conduit incorporating two 6-mm<sup>2</sup> 3C+E and two 16-mm<sup>2</sup> 3C+E power cables

|                     |   |                           |
|---------------------|---|---------------------------|
| Structural adequacy | - | not applicable            |
| Integrity           | - | no failure at 181 minutes |
| Insulation          | - | 151 minutes               |

Specimen 3 - SNAP MS70R Multi Services Retrofit fire collars protecting a bundle of 20 Category 5e network cables

|                     |   |                           |
|---------------------|---|---------------------------|
| Structural adequacy | - | not applicable            |
| Integrity           | - | no failure at 181 minutes |
| Insulation          | - | 180 minutes               |

Specimen 4 - SNAP MS70R Multi Services Retrofit fire collars protecting a bundle of 100 Category 5e network cables

|                     |   |                           |
|---------------------|---|---------------------------|
| Structural adequacy | - | not applicable            |
| Integrity           | - | no failure at 181 minutes |
| Insulation          | - | 166 minutes               |

Specimen 5 - SNAP MS70R Multi Services Retrofit fire collar protecting a ¾-in and a ⅜-in Pair Coil, a nominal 25-mm PN12 PVC-U pipe and a 2.5-mm<sup>2</sup> 3C+E power cable

|                     |   |                           |
|---------------------|---|---------------------------|
| Structural adequacy | - | not applicable            |
| Integrity           | - | no failure at 181 minutes |
| Insulation          | - | 175 minutes               |

Specimen 6 - SNAP MS70R Multi Services Retrofit fire collars protecting a bundle of six 16-mm<sup>2</sup> 3C+E and three 6-mm<sup>2</sup> 3C+E power cables

|                     |   |                           |
|---------------------|---|---------------------------|
| Structural adequacy | - | not applicable            |
| Integrity           | - | no failure at 181 minutes |
| Insulation          | - | 146 minutes               |

This report details methods of construction, the test conditions and the results obtained when the specific element of construction described herein was tested following the procedure outlined in AS 1530.4. Any significant variation with respect to size, constructional details, loads, stresses, edge or end conditions, other than those allowed under the field of direct application in the relevant test method, is not covered by this report.

Because of the nature of fire resistance testing and the consequent difficulty in quantifying the uncertainty of measurement of fire resistance, it is not possible to provide a stated degree of accuracy of the result.

## 9 Fire-resistance level (FRL)

For the purpose of building regulations in Australia, the FRL's of the test specimens were as follows:

Specimen 1 -/120/120

Specimen 2 -/120/120

Specimen 3 -/120/120

Specimen 4 -/120/120

Specimen 5 -/120/120

Specimen 6 -/120/120

The fire-resistance level is applicable when the system is exposed to fire from either direction.

The test was conducted on a wall system with an established FRL of -/120/120. The maximum FRL of any test specimen cannot exceed the FRL achieved by the wall system in which it was installed.

For the purposes of AS 1530.4-2014 the results of these fire tests may be used to directly assess fire hazard, but it should be noted that a single test method will not provide a full assessment of fire hazard under all fire conditions.

## 10 Field of direct application of test results

The results of the fire test contained in this test report are directly applicable, without reference to the testing authority, to similar constructions where one or more changes listed in Clause 10.12 of AS 1530.4-2014, have been made provided no individual component is removed or reduced.

## 11 Tested by



Peter Gordon  
Testing Officer

# Appendices

## Appendix A – Measurement location

| SPECIMEN   | T/C Position                                     | T/C designation |
|--|--|-----------------|
| <b>Specimen 1</b> - SNAP MS70R Multi Services Retrofit fire collars protecting a 1-inch copper pipe with Thermotec E-flex ST FRV and a thermoplastic-sheathed (TPS) cable.                       | On Plasterboard wall, 25 mm above collar         | S1              |
|  | On Plasterboard wall, 25 mm below collar         | S2              |
|  | On collar top left, 25-mm from P/B wall          | S3              |
|  | On collar top right, 25-mm from P/B wall         | S4              |
|  | On TPS cable, 25-mm from collar                  | S5              |
|  | On top of lagging, 25-mm from collar             | S6              |
|  | On right side of lagging, 25-mm from collar      | S7              |
| <b>Specimen 2</b> - SNAP MS70R Multi Services Retrofit fire collar protecting a nominal 50-mm PVC conduit incorporating two 16-mm <sup>2</sup> 3C+E and two 6-mm <sup>2</sup> 3C+E power cables. | On Plasterboard wall, 25 mm from collar top left | S8              |
|  | On Plasterboard wall, 25 mm below collar         | S9              |
|  | On collar top left, 25-mm from P/B wall          | S10             |
|  | On collar top right, 25-mm from P/B wall         | S11             |
|  | On top of pipe, 25-mm from collar                | S12             |
|  | On left of pipe, 25-mm from collar               | S13             |
| <b>Specimen 3</b> - SNAP MS70R Multi Services Retrofit fire collars protecting a bundle of 20 Category 5e network cables.  | On Plasterboard wall, 25 mm from collar top left | S14             |
|  | On Plasterboard wall, 25 mm below collar         | S15             |
|  | On collar top left, 25-mm from P/B wall          | S16             |
|  | On collar top right, 25-mm from P/B wall         | S17             |
|  | On top of cables, 25-mm from collar              | S18             |
|  | On bottom of cables, 25-mm from collar           | S19             |
| <b>Specimen 4</b> - SNAP MS70R Multi Services Retrofit fire collars protecting a bundle of 100 Category 5e network cables.   | On Plasterboard wall, 25 mm from collar top left | S20             |
|  | On Plasterboard wall, 25 mm below collar         | S21             |
|  | On collar top left, 25-mm from P/B wall          | S22             |
|  | On collar top right, 25-mm from P/B wall         | S23             |
|  | On top of cables, 25-mm from collar              | S24             |
|  | On bottom of cables, 25-mm from collar           | S25             |



| SPECIMEN   | T/C Position  | T/C designation |
|--|---|-----------------|
| <b>Specimen 5</b> - SNAP MS70R Multi Services Retrofit fire collar protecting a ¾-in and a ⅝-in Pair Coils, a nominal 25-mm pressure PN12 PVC-U pipe and a 2.5-mm <sup>2</sup> 3C+E power cable. | On Plasterboard wall, 25 mm from collar – top right | S26             |
|  | On Plasterboard wall, 25 mm below collar            | S27             |
|  | On collar top left, 25-mm from P/B wall             | S28             |
|  | On collar top right, 25-mm from P/B wall            | S29             |
|  | On PVC pipe, 25-mm from collar                      | S30             |
|  | On ¾-in pipe lagging, 25-mm from collar             | S31             |
|  | On ⅝-in pipe lagging, 25-mm from collar             | S32             |
|  | On power cable, 25-mm from collar                   | S33             |
| <b>Specimen 6</b> - SNAP MS70R Multi Services Retrofit fire collars protecting a bundle six 16-mm <sup>2</sup> 3C+E and three 6-mm <sup>2</sup> 3C+E power cables.                               | On Plasterboard wall, 25 mm from collar top left    | S34             |
|  | On Plasterboard wall, 25 mm below collar            | S35             |
|  | On collar top left, 25-mm from P/B wall             | S36             |
|  | On collar top right, 25-mm from P/B wall            | S37             |
|  | On 16-mm <sup>2</sup> cable, 25-mm from collar      | S38             |
|  | On 6-mm <sup>2</sup> cable, 25-mm from collar       | S39             |
| Rover  |   | S42             |
| Ambient  |   | S43             |

## Appendix B – Photographs

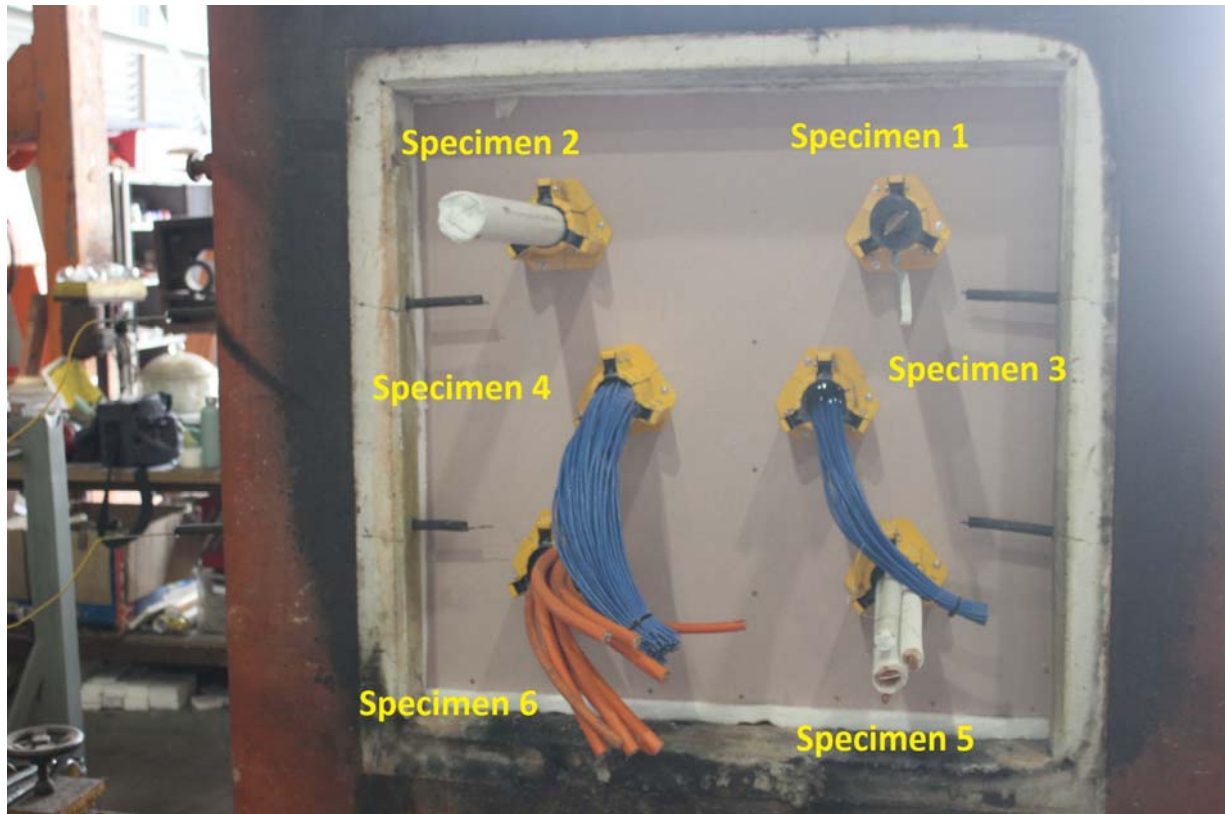

**PHOTOGRAPH 1 – EXPOSED FACE OF SPECIMENS PRIOR TO TESTING**

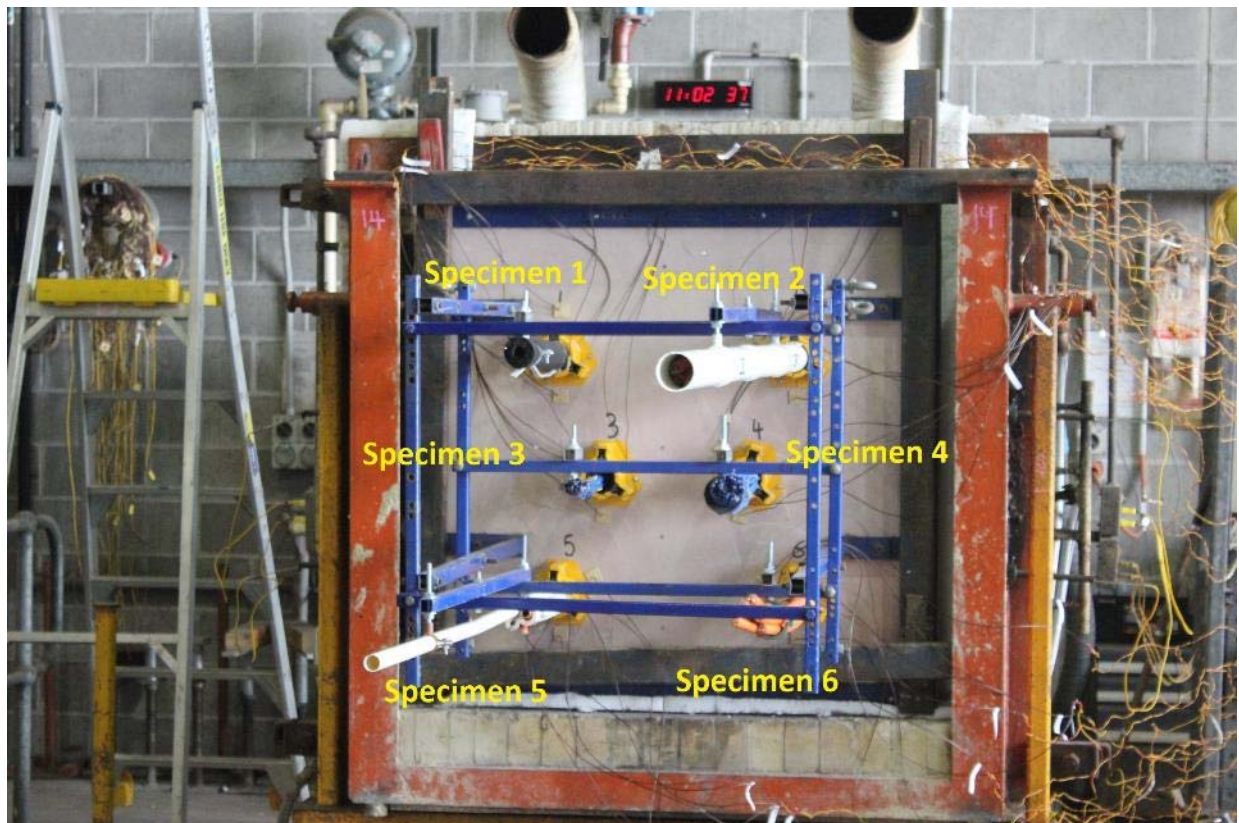

**PHOTOGRAPH 2 – UNEXPOSED FACE OF SPECIMENS PRIOR TO TESTING**



**PHOTOGRAPH 3 – SPECIMENS AFTER 2 MINUTES OF TESTING**



**PHOTOGRAPH 4 – SPECIMENS AFTER 4 MINUTES OF TESTING**



**PHOTOGRAPH 5 – SPECIMEN 1 AFTER 18 MINUTES OF TESTING**

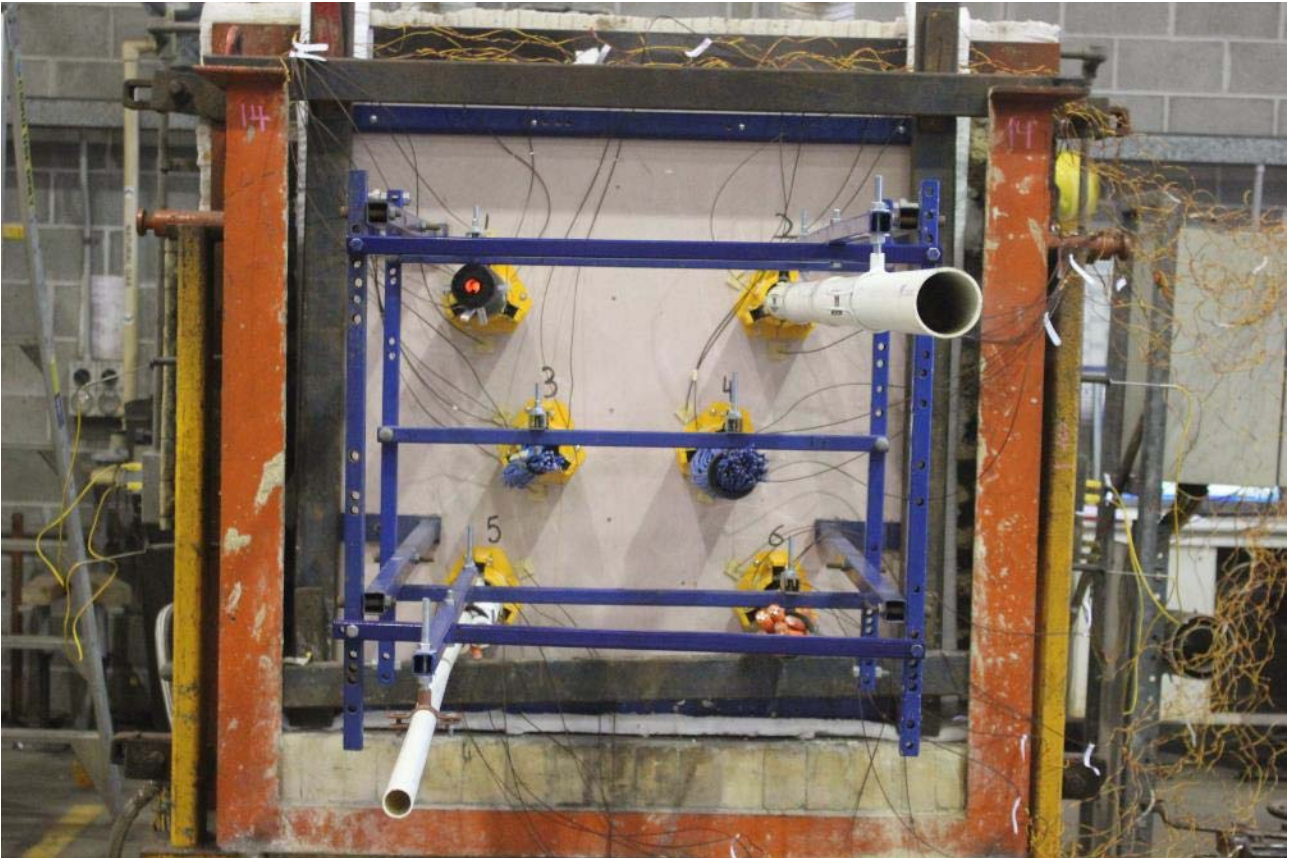

**PHOTOGRAPH 6 – SPECIMENS AFTER 30 MINUTES OF TESTING**

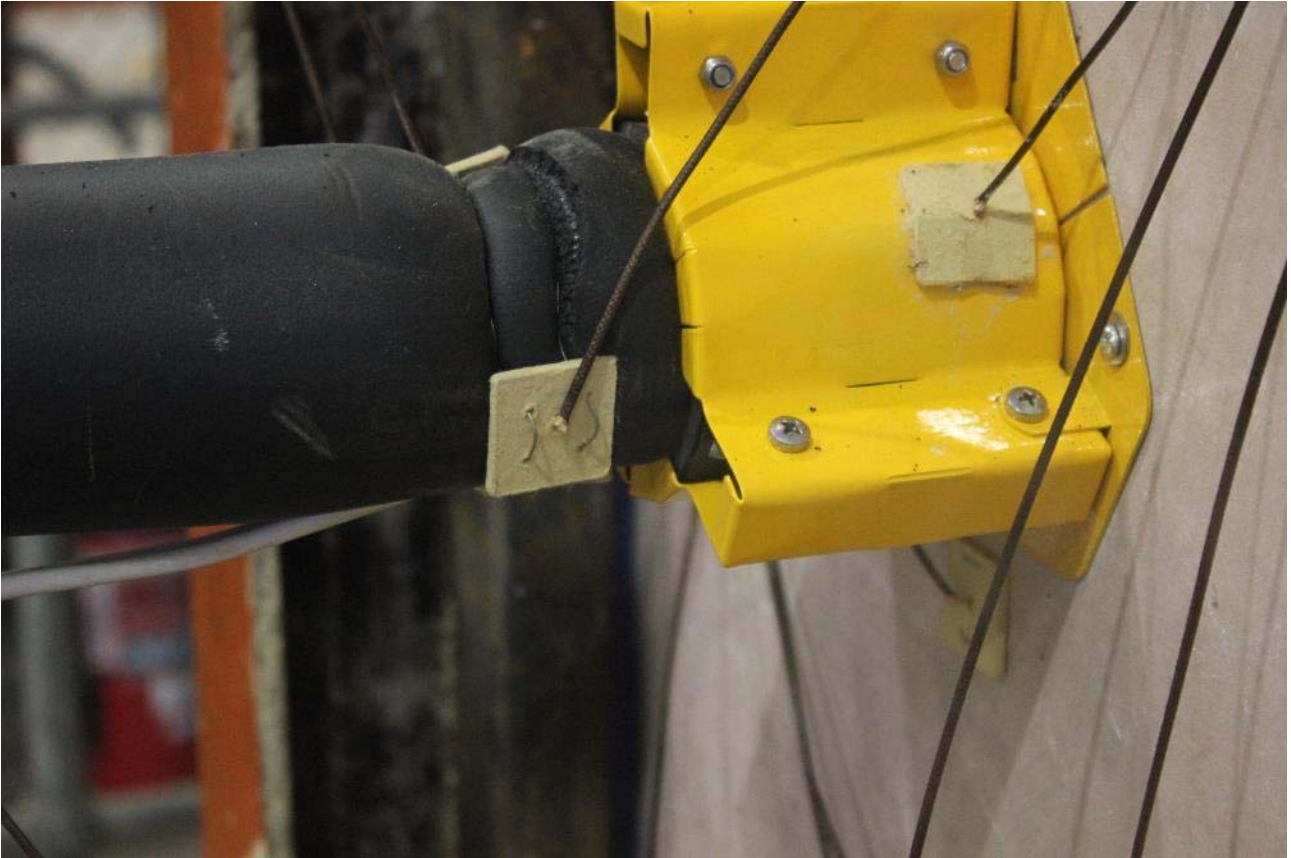

**PHOTOGRAPH 7 – SPECIMEN 1 AFTER 32 MINUTES OF TESTING**



**PHOTOGRAPH 8 – SPECIMEN 6 AFTER 40 MINUTES OF TESTING**

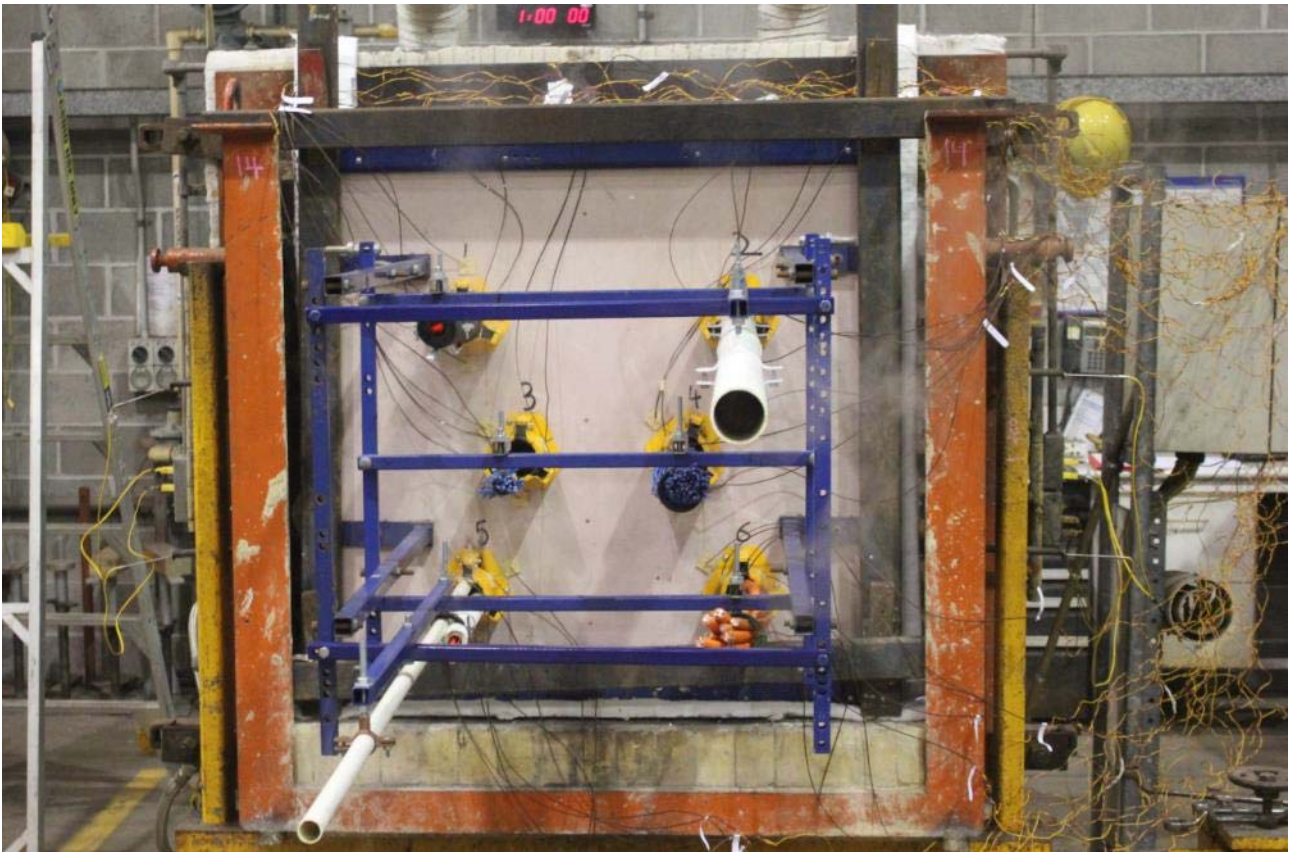

**PHOTOGRAPH 9 – SPECIMENS AFTER 60 MINUTES OF TESTING**



**PHOTOGRAPH 10 – SPECIMEN 6 AFTER 62 MINUTES OF TESTING**

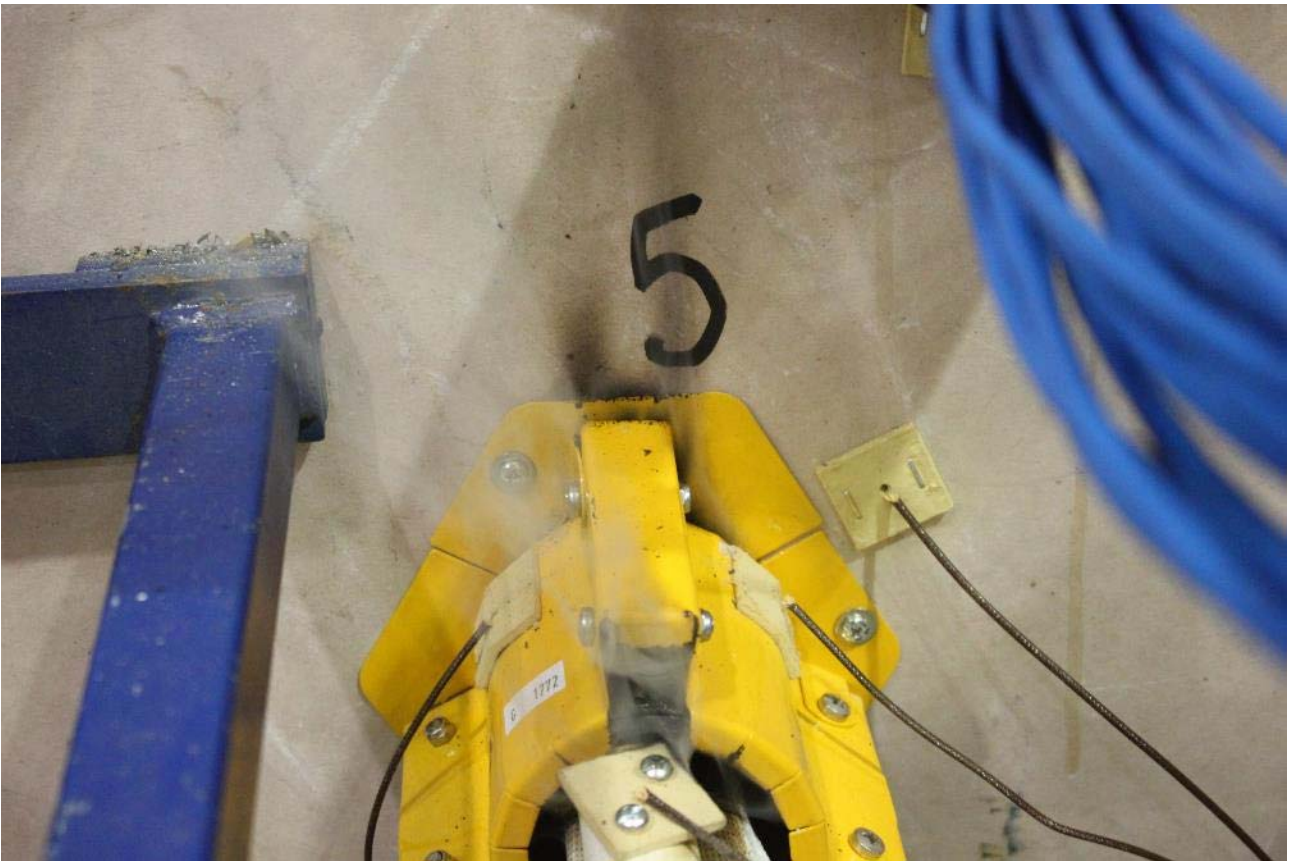

**PHOTOGRAPH 11 – SPECIMEN 5 AFTER 75 MINUTES OF TESTING**

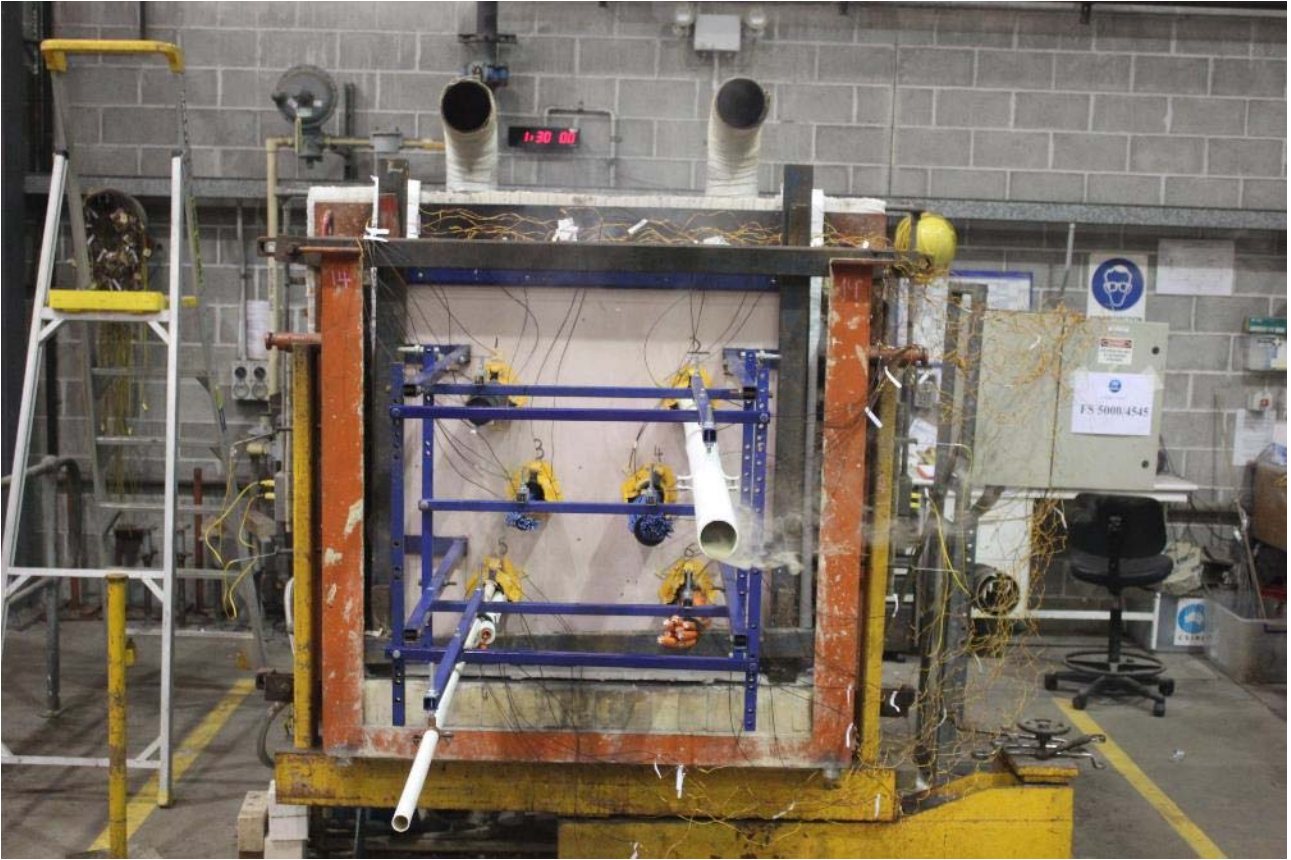

**PHOTOGRAPH 12 – SPECIMENS AFTER 90 MINUTES OF TESTING**



**PHOTOGRAPH 13 – SPECIMENS AFTER 120 MINUTES OF TESTING**



**PHOTOGRAPH 14 – SPECIMEN 3 AFTER 138 MINUTES OF TESTING**





**PHOTOGRAPH 15 – SPECIMENS AFTER 180 MINUTES OF TESTING**

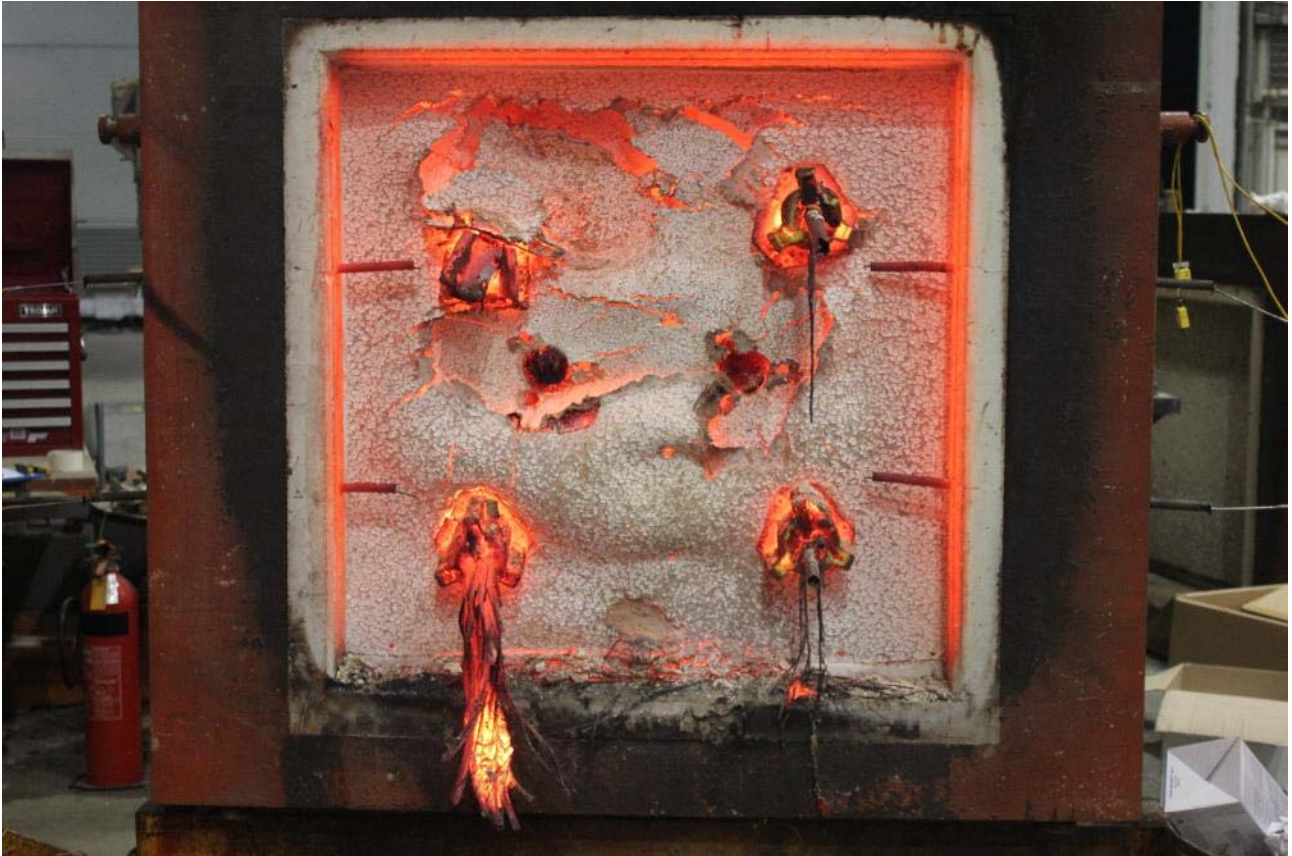

**PHOTOGRAPH 16 – EXPOSED FACE OF SPECIMENS AT CONCLUSION OF TESTING**

## Appendix C – Furnace Temperature

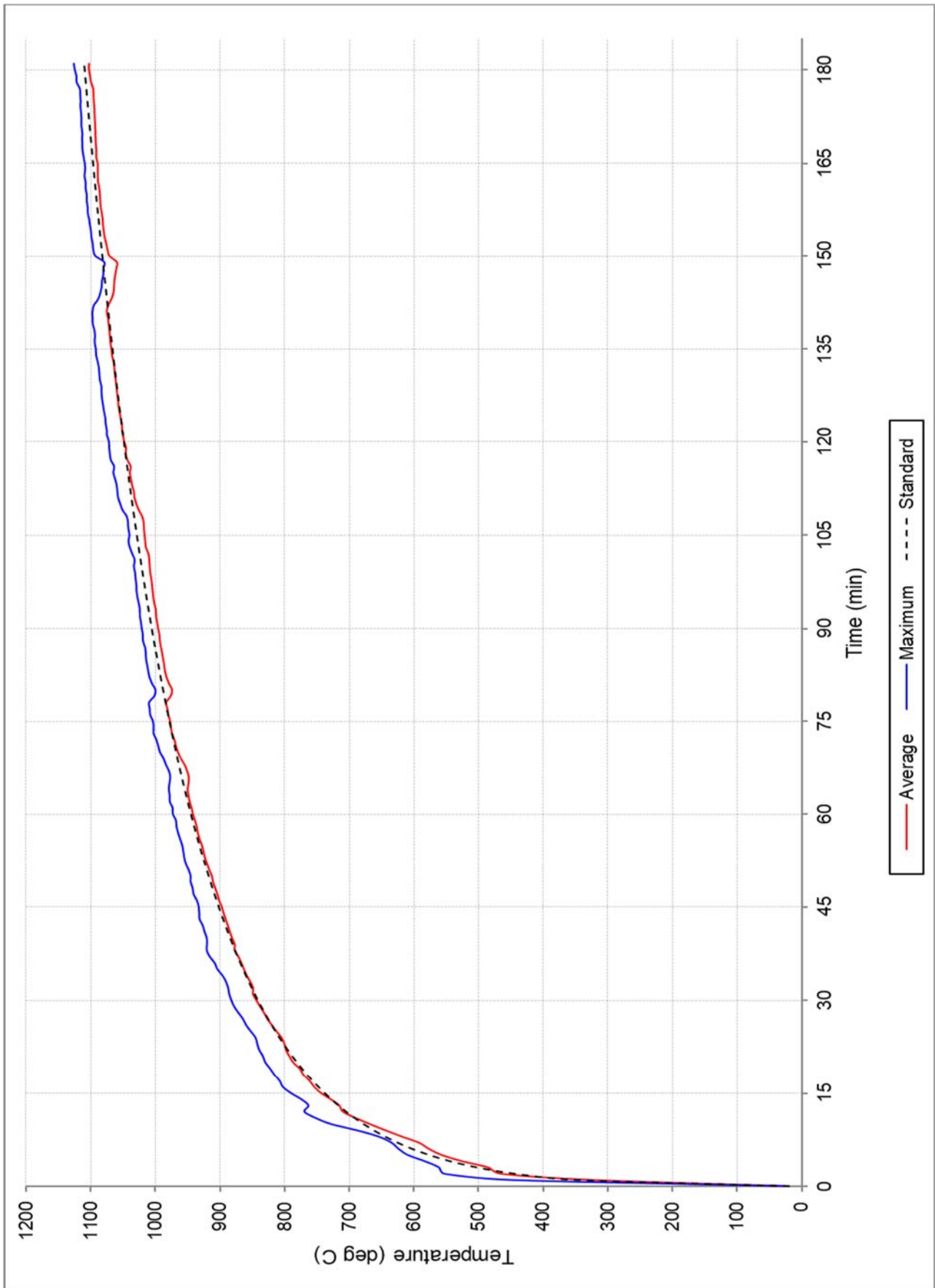

FIGURE 1 – FURNACE TEMPERATURE

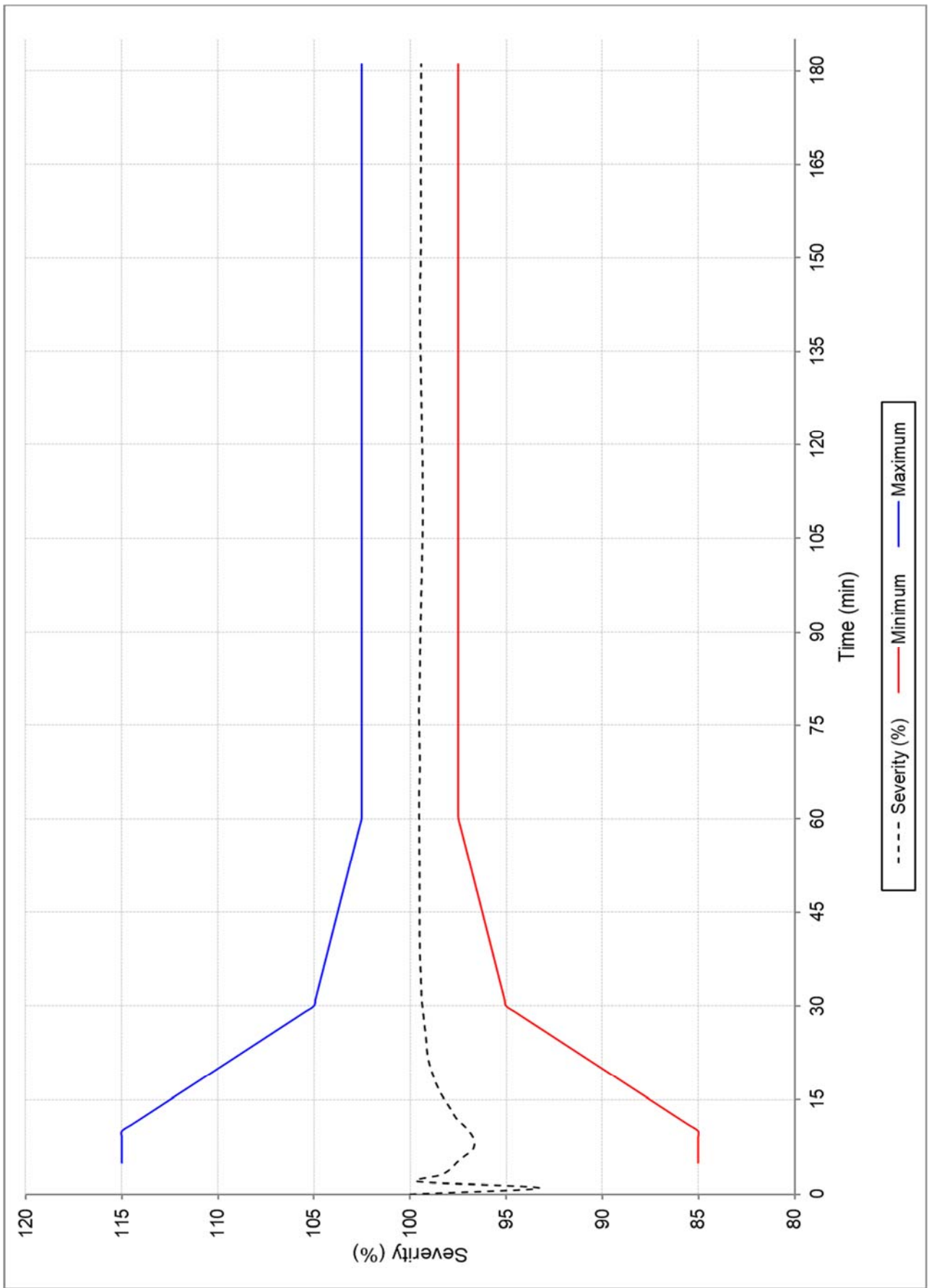

FIGURE 2 – FURNACE SEVERITY

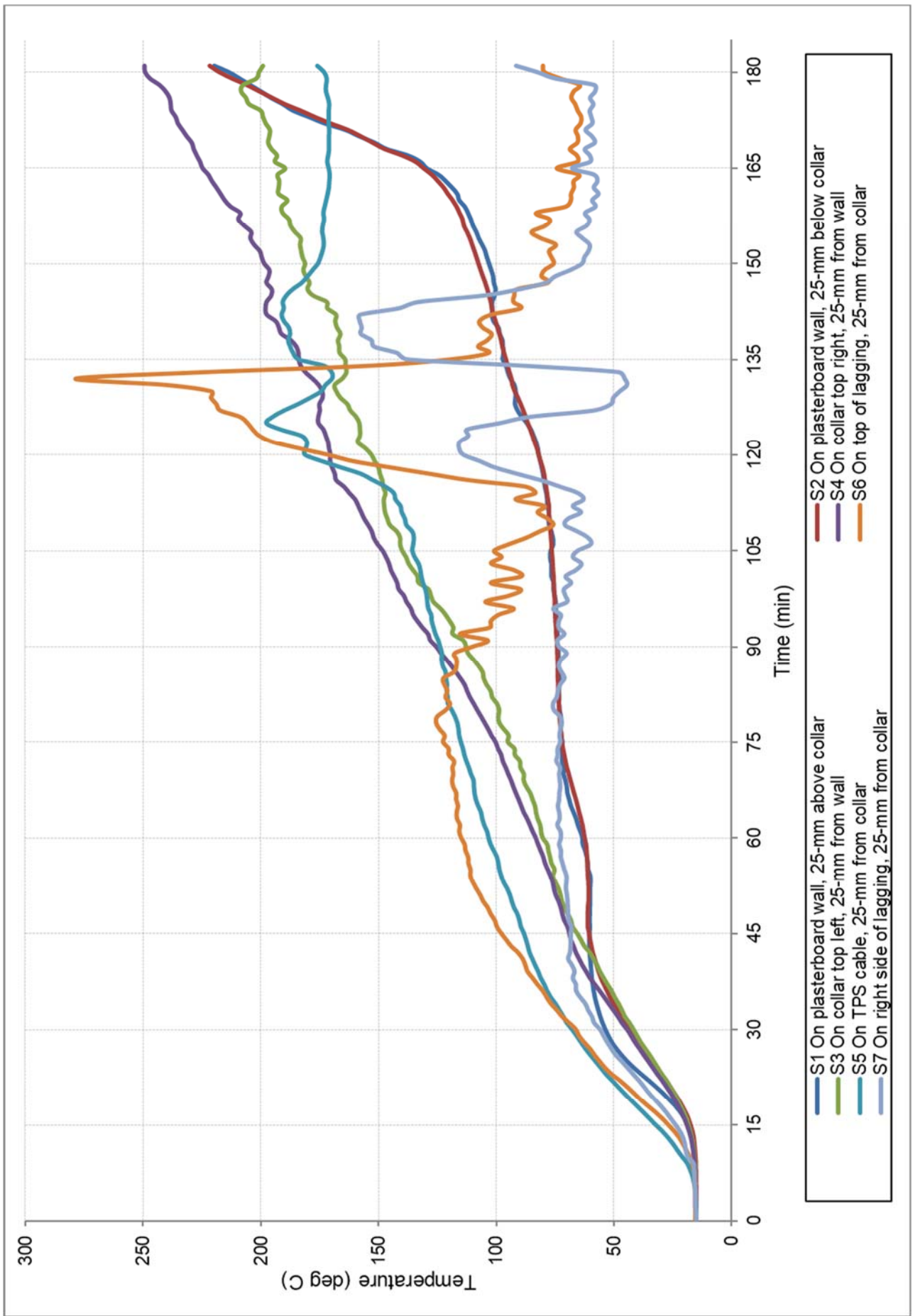

FIGURE 3 - TEMPERATURE VERSUS TIME ASSOCIATED WITH SPECIMEN #1

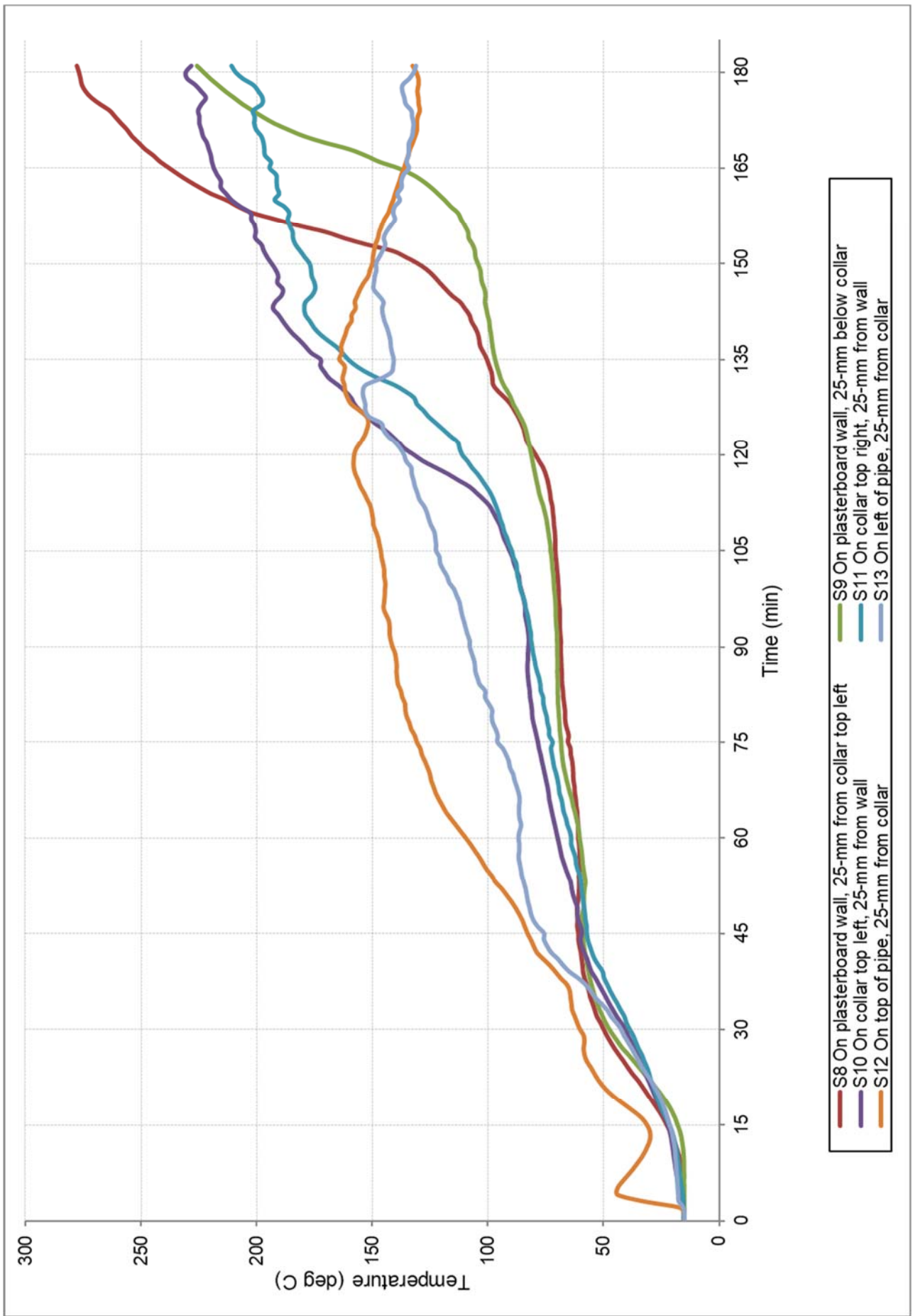

FIGURE 4 - TEMPERATURE VERSUS TIME ASSOCIATED WITH SPECIMEN #2

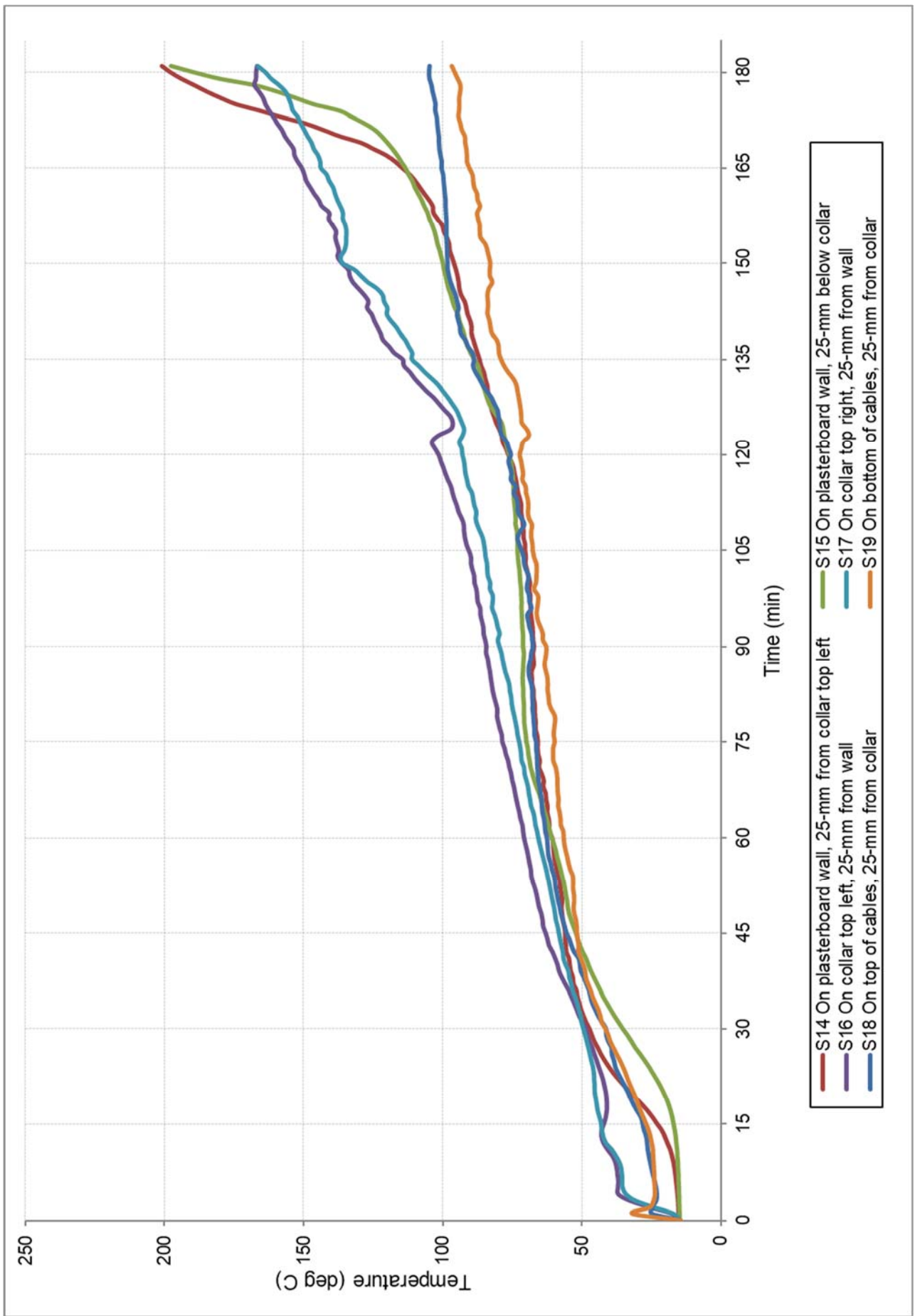

FIGURE 5 - TEMPERATURE VERSUS TIME ASSOCIATED WITH SPECIMEN #3

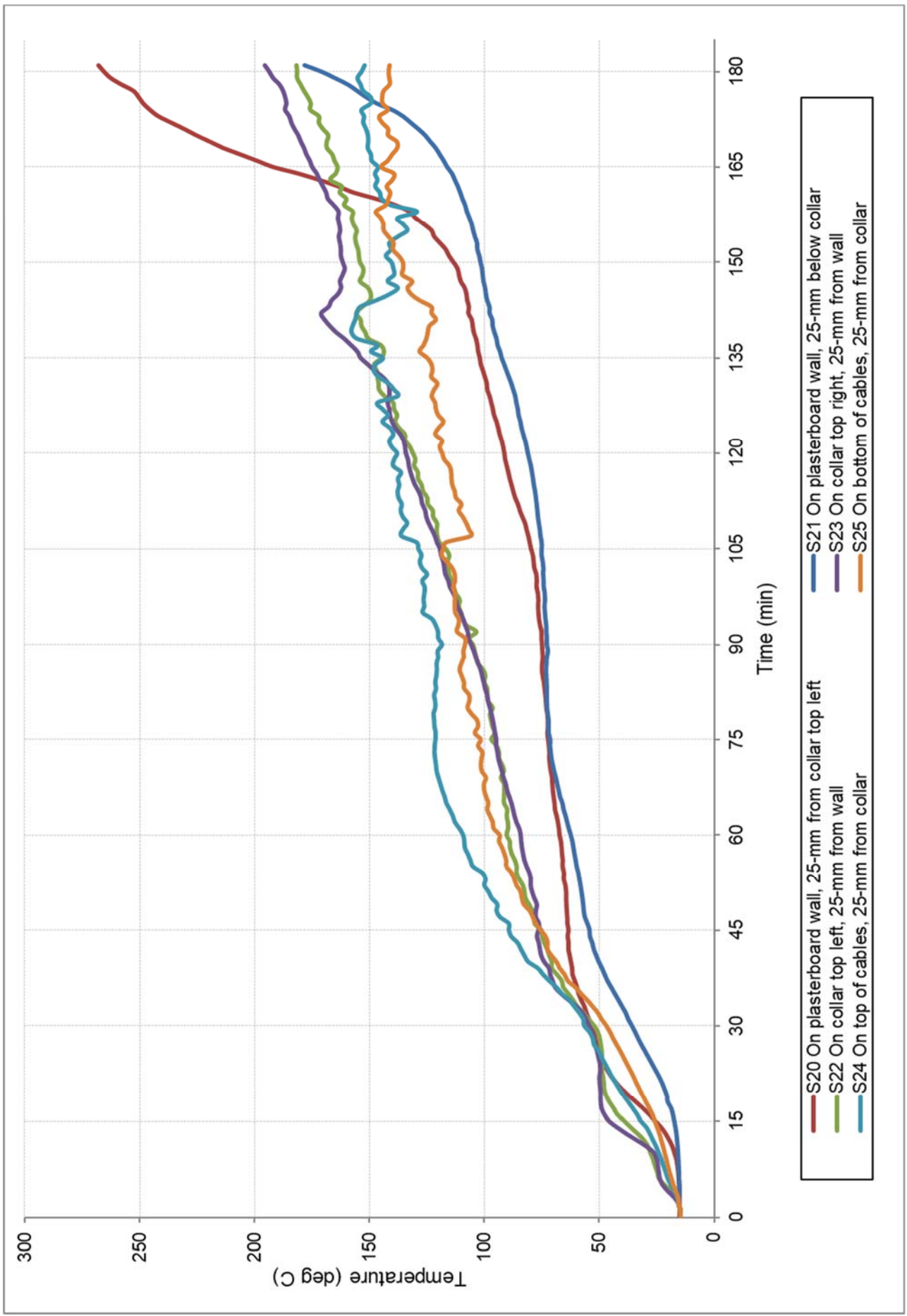

FIGURE 6 - TEMPERATURE VERSUS TIME ASSOCIATED WITH SPECIMEN #4

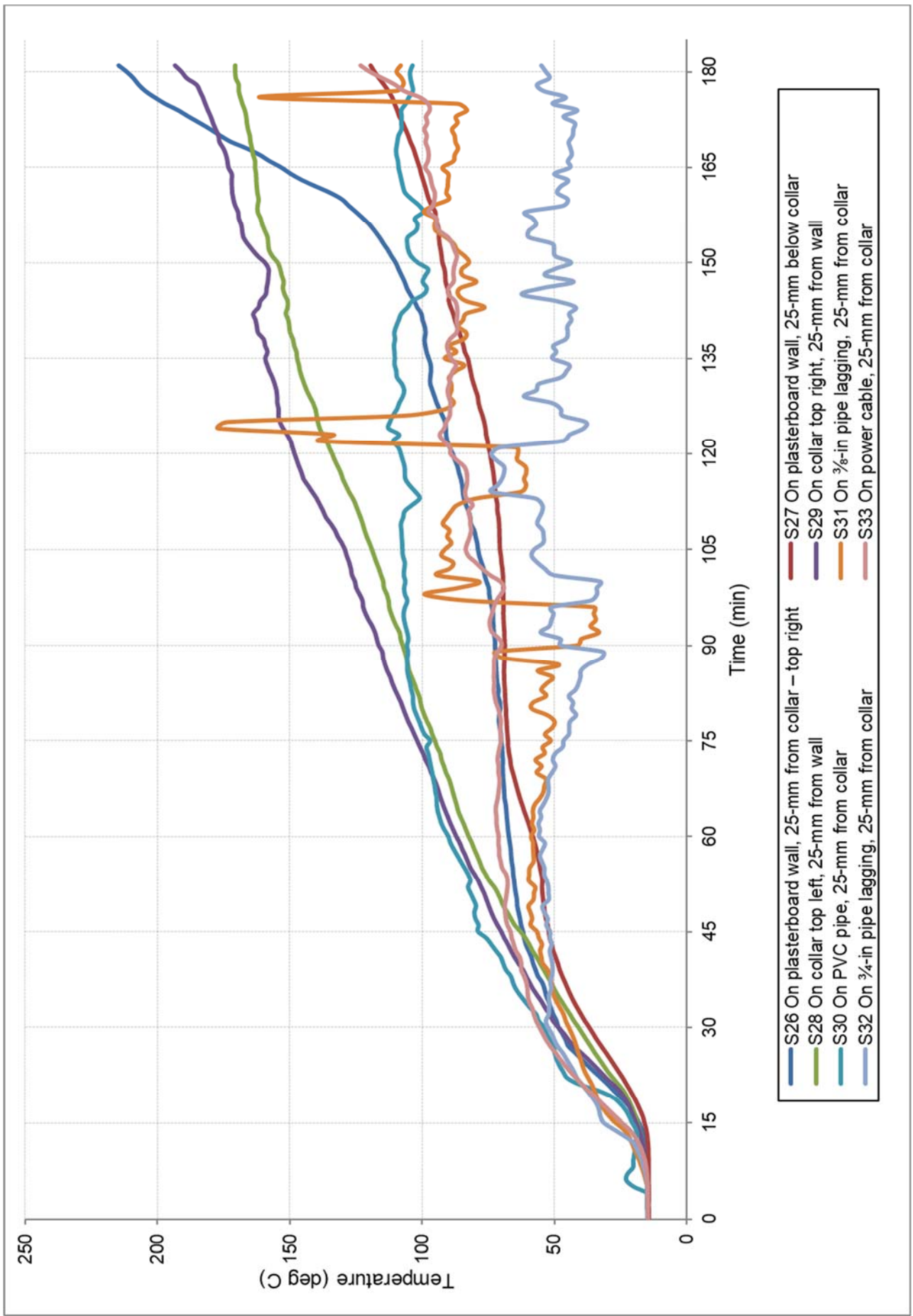

FIGURE 7 - TEMPERATURE VERSUS TIME ASSOCIATED WITH SPECIMEN #5



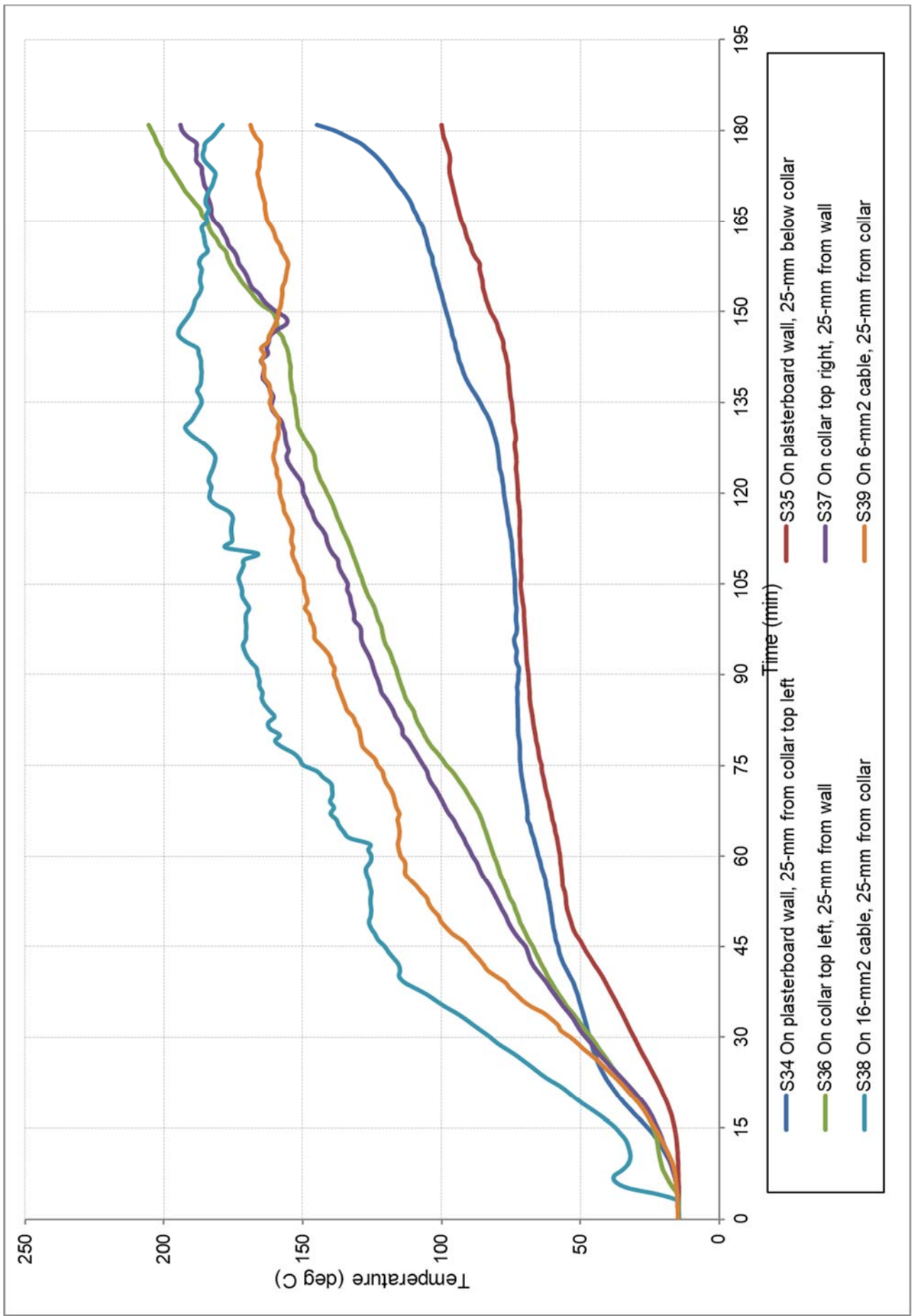

FIGURE 8 - TEMPERATURE VERSUS TIME ASSOCIATED WITH SPECIMEN #6

## Appendix D – Layout and installation drawings

### Snap Fire Systems Pty Ltd

Test Wall W-20-G Layout

Date: 10 JUN 2020

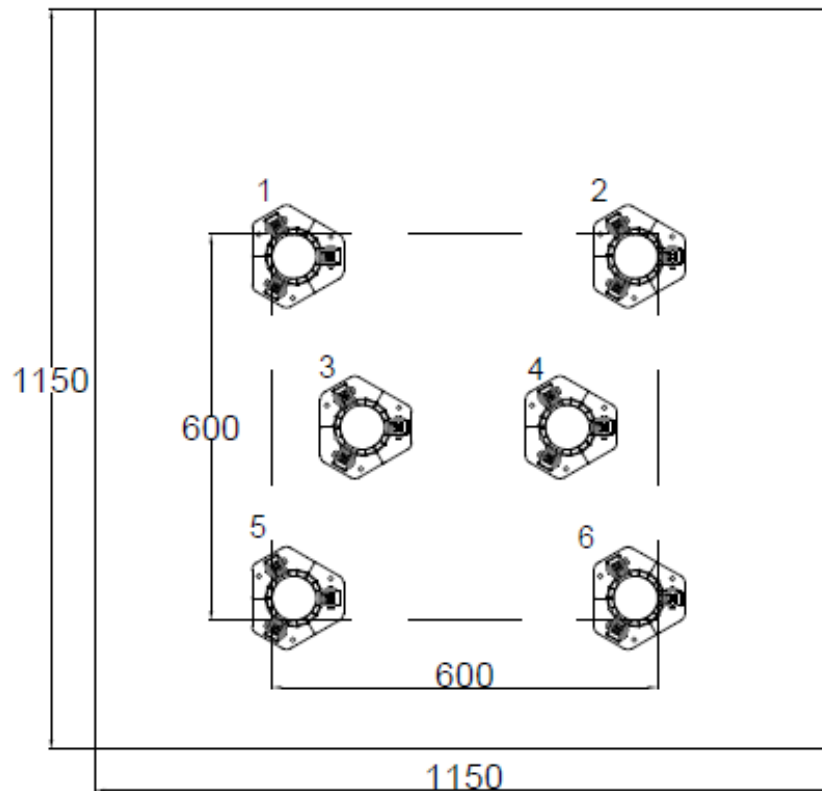

| Penetration | Collar Code | Pipe Type   | Pipe Diameter  |
|-------------|-------------|---|--|
| 1           | MS70R       | Copper Tube with F/R lagging and TPS cable  | 1in(19mm Lagging) & 2.5mm <sup>2</sup> 3C                  |
| 2           | MS70R       | Medium Duty PVC Conduit with Orange Power Cables  | 50, 2x(16mm <sup>2</sup> 3C+E) & 2x(6mm <sup>2</sup> 3C+E) |
| 3           | MS70R       | 20xCat5e Cables   |  |
| 4           | MS70R       | 100xCat5e Cables  |  |
| 5           | MS70R       | Copper pair coil lagged in non-F/R lagging, 3 core+E round power cable and pressure PVC | 3/8 & 3/4 in (9mm Lagging), 2.5mm <sup>2</sup> 3C+E, 25mm  |
| 6           | MS70R       | Orange Power Cables   | 3x(6mm <sup>2</sup> 3C+E) & 6x(16mm <sup>2</sup> 3C+E)     |

**DRAWING TITLED “TEST WALL W-20-G LAYOUT, DATED 10 JUNE 2020, PROVIDED BY SNAP FIRE SYSTEMS PTY LTD.**

# Snap Fire Systems Pty Ltd

Specimen #1

1inch Copper Tube with 19mm F/R Lagging,  
2.5mm<sup>2</sup> 3C TPS Cable & MS70R Collar

Date: 11 JUN 2020

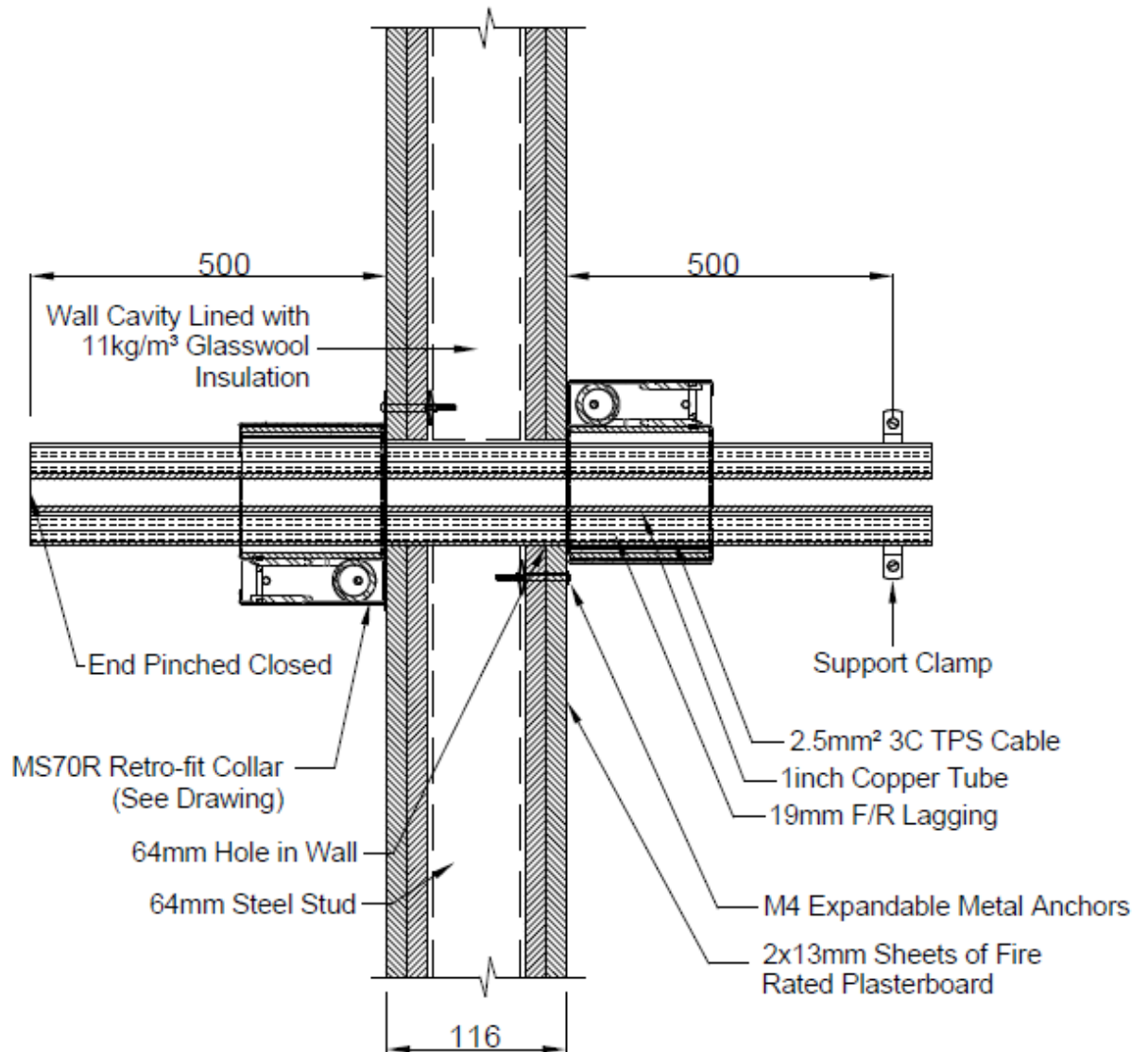

**DRAWING TITLED "SPECIMEN # 1 1INCH COPPER TUBE WITH 19MM F/R LAGGING, 3C TPS CABLE & MS70R COLLAR", DATED 11 JUNE 2020, PROVIDED BY SNAP FIRE SYSTEMS PTY LTD**

# Snap Fire Systems Pty Ltd

Specimen #2

50 PVC Conduit with 16mm<sup>2</sup> 3C+E &  
6mm<sup>2</sup> 3C+E Power Cables & MS70R Collar

Date: 11 JUN 2020

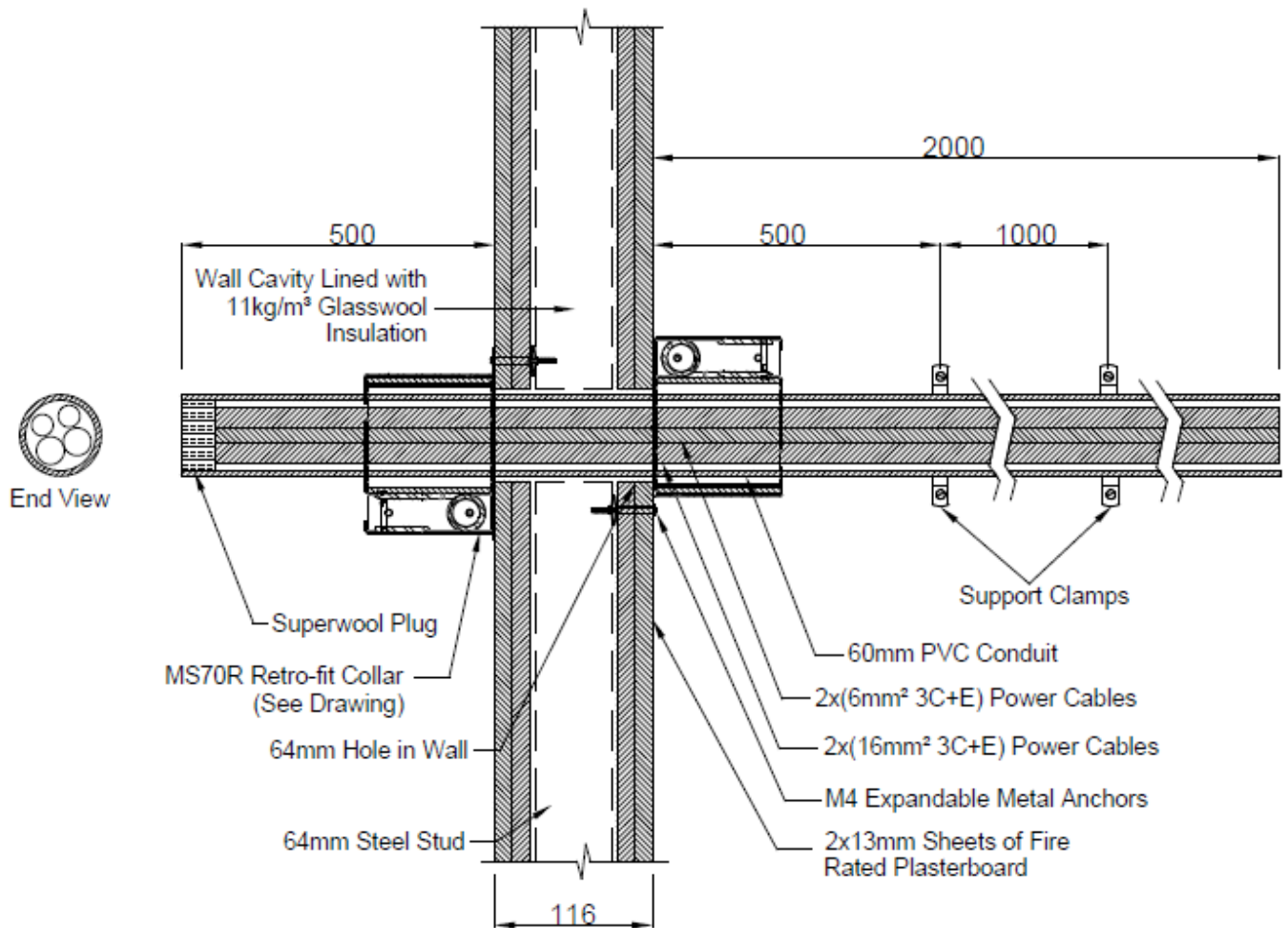

**DRAWING TITLED "SPECIMEN #2 50 PVC CONDUIT WITH 16MM<sup>2</sup> 3C+E & 6MM<sup>2</sup> 3C+E POWER CABLES & MS70R COLLAR", DATED 11 JUNE 2020, PROVIDED BY SNAP FIRE SYSTEMS PTY LTD**

# Snap Fire Systems Pty Ltd

Specimen #3

20% Full of Cat5e Cables & MS70R Collar

Date: 11 JUN 2020

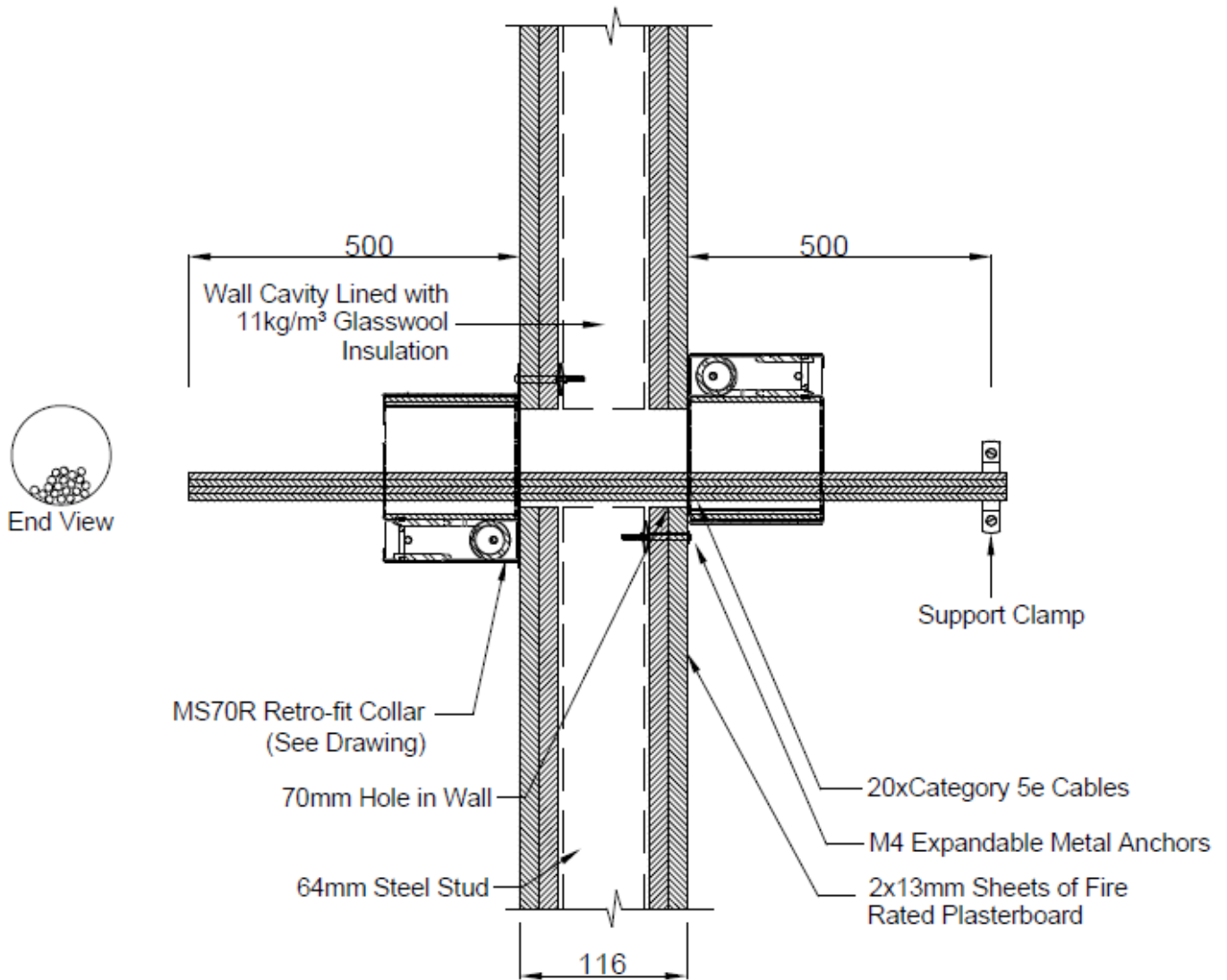

**DRAWING TITLED "SPECIMEN #3 20% FULL OF CAT5E CABLES & MS70R COLLAR", DATED 11 JUNE 2020,  
PROVIDED BY SNAP FIRE SYSTEMS PTY LTD, PROVIDED BY SNAP FIRE SYSTEMS PTY LTD**

# Snap Fire Systems Pty Ltd

Specimen #4

100% Full of Cat5e Cables & MS70R Collar

Date: 11 JUN 2020

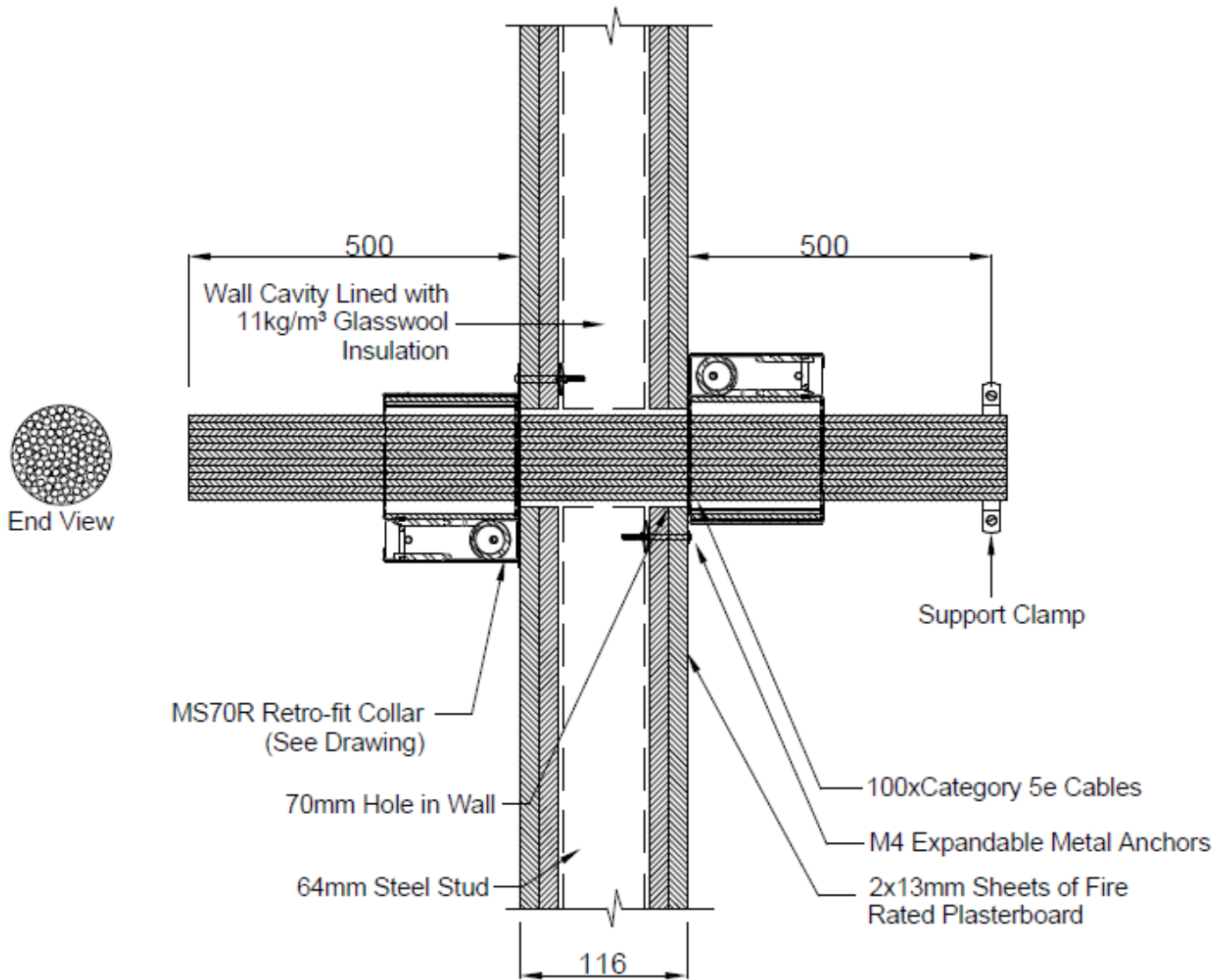

**DRAWING TITLED "SPECIMEN #4 100% FULL OF CAT5E CABLES & MS70R COLLAR", DATED 11 JUNE 2020, PROVIDED BY SNAP FIRE SYSTEMS PTY LTD, PROVIDED BY SNAP FIRE SYSTEMS PTY LTD**

# Snap Fire Systems Pty Ltd

Specimen #5

$\frac{3}{4}$ -in &  $\frac{3}{8}$ -in Insulated Copper Pair Coil, 25mm Pressure PVC,  
2.5mm<sup>2</sup> 3C+E Cable & MS70R

Date: 11 JUN 2020

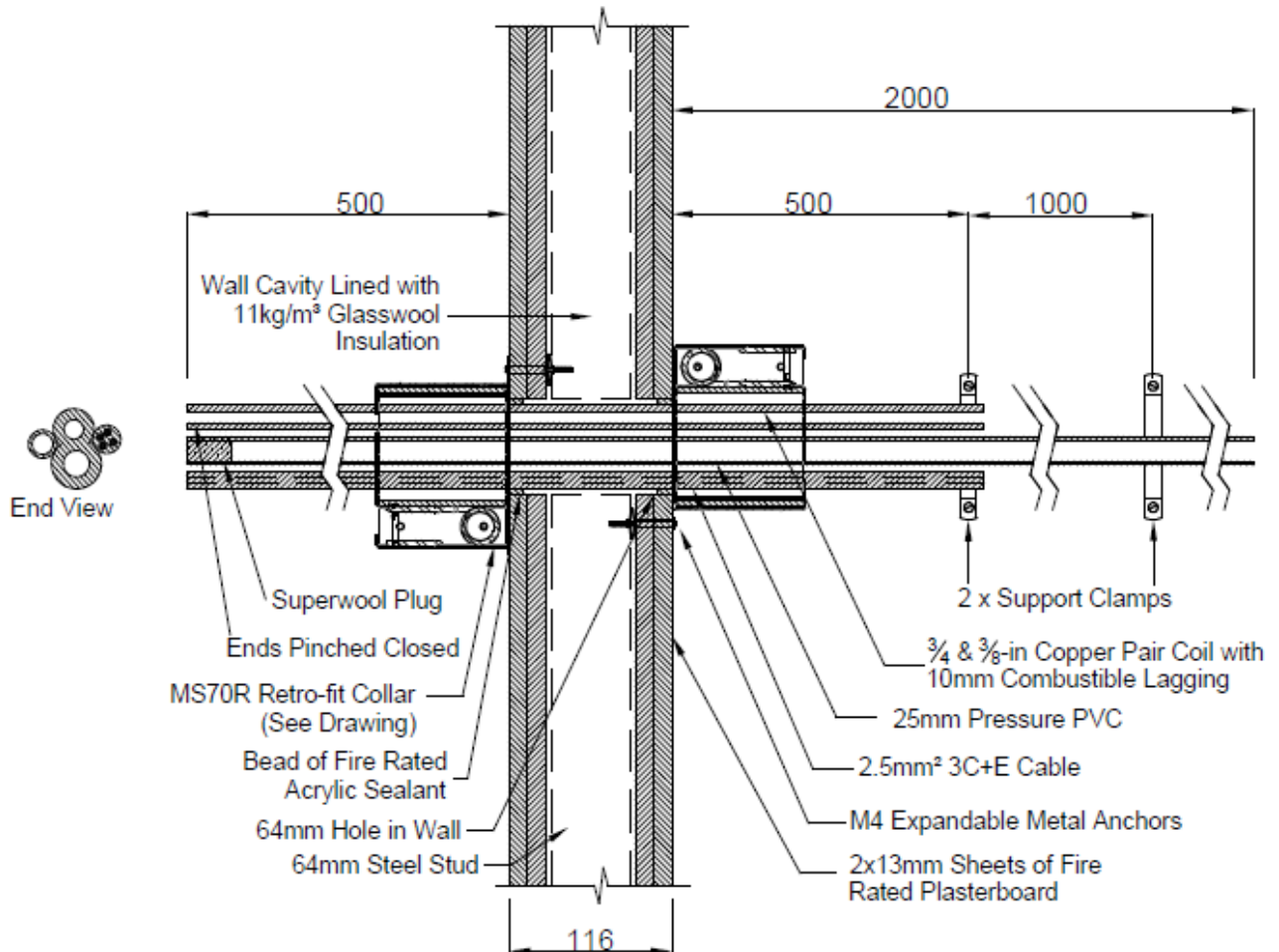

**DRAWING TITLED "SPECIMEN #5  $\frac{3}{4}$ -IN &  $\frac{3}{8}$ -IN INSULATED COPPER PAIR COIL, 25-MM PRESSURE PVC, 2.5MM<sup>2</sup> 3C+E CABLE & MS70R", DATED 11 JUNE 2020, PROVIDED BY SNAP FIRE SYSTEMS PTY LTD**

# Snap Fire Systems Pty Ltd

Specimen #6

16mm<sup>2</sup> 3C+E & 6mm<sup>2</sup> 3C+E Power Cables | & MS70R Collar

Date: 11 JUN 2020

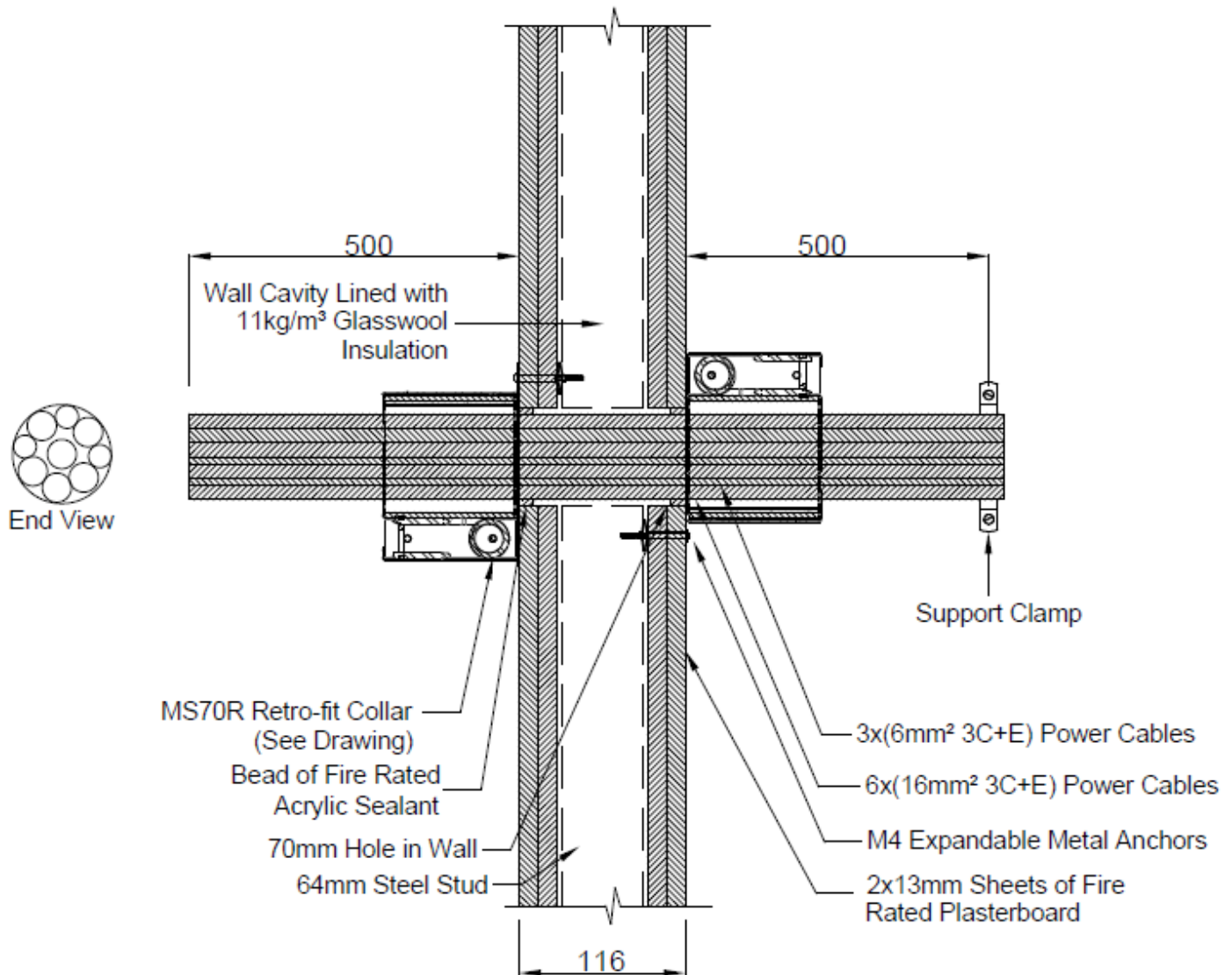

DRAWING TITLED "SPECIMEN #6 16MM<sup>2</sup> 3C+E & 6MM<sup>2</sup> 3C+E POWER CABLES & MS70R COLLAR", DATED 11 JUNE 2020, PROVIDED BY SNAP FIRE SYSTEMS PTY LTD



Appendix E – Specimen Drawings

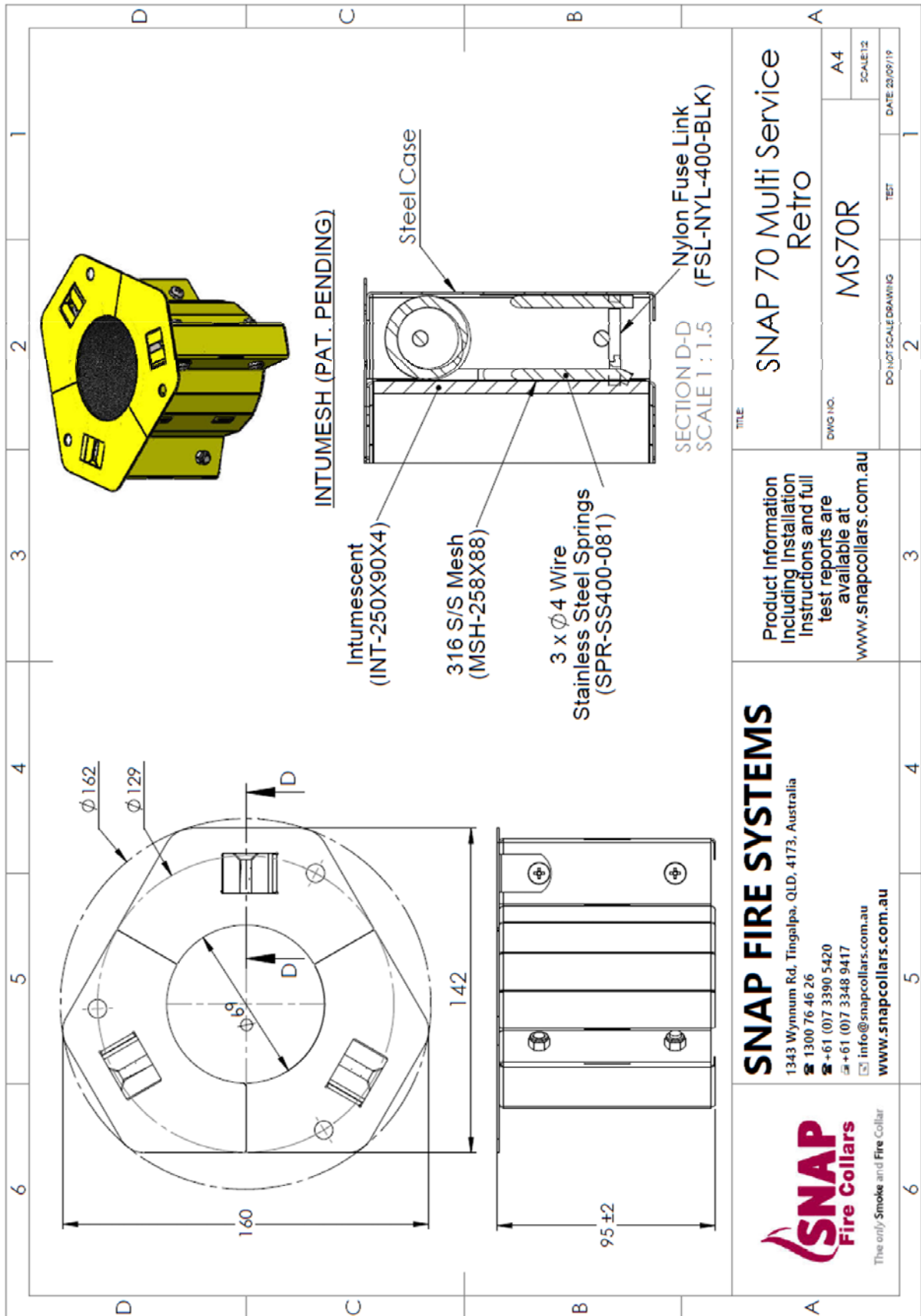

DRAWING TITLED “SNAP 70 MULTI SERVICE RETRO”, DATED 23 SEPTEMBER 2019, BY SNAP FIRE SYSTEMS.





## Certificate of Test

No. 3486

This is to certify that the element of construction described below was tested by CSIRO Infrastructure Technologies in accordance with Australian Standard 1530, Methods for fire tests on building materials, components and structures, Part 4 Fire-resistance tests of elements of construction, 2014, Section 10: Service penetrations and control joints, on behalf of:

IG6 Pty Ltd as trustee for the IG6 IP Trust  
3 Skirmish Court  
Victoria Point Qld 4165

A full description of the test specimen and the complete test results are detailed in the Division's report numbered FSP 2126.

Product Name: SNAP MS70R Multi Services Retrofit fire collar protecting a nominal 50-mm PVC conduit incorporating two 6-mm<sup>2</sup> 3C+E and two 16-mm<sup>2</sup> 3C+E power cables (Specimen 2)

Description: The specimen comprised an 1150-mm x 1150-mm x 116-mm thick plasterboard wall system penetrated by a service protected by retro-fitted Snap Fire Systems fire collars. The plasterboard wall was constructed in accordance with Boral Firestop system SB120.1 with an established fire resistance level (FRL) of -/120/120 as detailed in the document titled "Plasterboard Fire and Acoustic Systems Australia", revision UB1231-SYS 12/18, by USG Boral Building Products Pty Ltd. The SNAP Multi Service Retrofit MS70R fire collar comprised a 0.75-mm thick steel casing with a 69-mm inner diameter and a 0.95-mm thick steel base flange with a 162-mm diameter as shown in drawing titled "SNAP 70 Multi Service Retro", dated 23 September 2019, by Snap Fire Systems Pty Ltd. One collar was fixed to each side of the wall in a back-to-back configuration through the collar mounting brackets using three M4 expandable steel anchors. The penetrating service comprised a 60-mm outside diameter Telstra PVC conduit with a wall thickness of 2.71-mm containing two 6-mm<sup>2</sup> 3-core+E power cables and two 16-mm<sup>2</sup> 3 core+E power cables running through the conduit as shown in drawing titled "Specimen #2 50 PVC Conduit with 16mm<sup>2</sup> 3C+E & 6mm<sup>2</sup> 3C+E Power Cables & MS70R Collar", dated 11 June 2020, by Snap Fire Systems Pty Ltd. The conduit and cables projected horizontally, 2000-mm away from the unexposed face of the wall and approximately 500 mm into the furnace chamber. The conduit was supported at nominally 500 mm and 1500 mm from the unexposed face of the plasterboard wall. The conduit was open at the unexposed end and plugged with ceramic fibre (Superwool) on the exposed end.

Performance observed in respect of the following AS 1530.4-2014 criteria

|                     |   |                           |
|---------------------|---|---------------------------|
| Structural Adequacy | - | not applicable            |
| Integrity           | - | no failure at 181 minutes |
| Insulation          | - | 151 minutes               |

and therefore for the purpose of Building Regulations in Australia, achieved a fire-resistance level (FRL) of -/120/120.

The fire-resistance level (FRL) of the specimen is applicable when the system is exposed to fire from either direction. The maximum FRL of any test specimen cannot exceed the FRL achieved by the system in which it was installed. For the purposes of AS 1530.4-2014 the results of these fire tests may be used to directly assess fire hazard, but it should be noted that a single test method will not provide a full assessment of fire hazard under all fire conditions. This certificate is provided for general information only and does not comply with regulatory requirements for evidence of compliance.

Testing Officer: Peter Gordon Date of Test: 6 July 2020

Issued on the 8<sup>th</sup> day of September 2020 without alterations or additions.

Brett Roddy | Manager, Fire Testing and Assessments

"Copyright CSIRO 2020 ©"

Copying or alteration of this report without written authorisation from CSIRO is forbidden



This document is issued in accordance with NATA's accreditation requirements.  
Accreditation No. 165 – Corporate Site No. 3625  
Accredited for compliance with ISO/IEC 17025 - Testing

**COPY OF CERTIFICATE OF TEST – NO. 3486**



## Certificate of Test

No. 3487

This is to certify that the element of construction described below was tested by CSIRO Infrastructure Technologies in accordance with Australian Standard 1530, Methods for fire tests on building materials, components and structures, Part 4 Fire-resistance tests of elements of construction, 2014, Section 10: Service penetrations and control joints, on behalf of:

IG6 Pty Ltd as trustee for the IG6 IP Trust  
3 Skirmish Court  
Victoria Point Qld 4165

A full description of the test specimen and the complete test results are detailed in the Division's report numbered FSP 2126.

Product Name: SNAP MS70R Multi Services Retrofit fire collars protecting a bundle of 20 Category 5e network cables (Specimen 3)

Description: The specimen comprised an 1150-mm x 1150-mm x 116-mm thick plasterboard wall system penetrated by a service protected by retro-fitted Snap Fire Systems fire collars. The plasterboard wall was constructed in accordance with Boral Firestop system SB120.1 with an established fire resistance level (FRL) of -/120/120 as detailed in the document titled "Plasterboard Fire and Acoustic Systems Australia", revision UB1231-SYS 12/18, by USG Boral Building Products Pty Ltd. The SNAP Multi Service Retrofit MS70R fire collar comprised a 0.75-mm thick steel casing with a 69-mm inner diameter and a 0.95-mm thick steel base flange with a 162-mm diameter as shown in drawing titled "SNAP 70 Multi Service Retro", dated 23 September 2019, by Snap Fire Systems Pty Ltd. One collar was fixed to each side of the wall in a back-to-back configuration through the collar mounting brackets using three M4 expandable steel anchors. The penetrating service comprised a bundle of 20 ADC Krone Category 5e network cables as shown in drawing titled "Specimen #3 20% Full of Cat5e Cables & MS70R Collar", dated 11 June 2020, by Snap Fire Systems Pty Ltd. The cables projected horizontally 550 mm away from the unexposed face of the wall and approximately 500 mm into the furnace chamber. The cables were supported at nominally 500 mm from the unexposed face of the plasterboard wall.

Performance observed in respect of the following AS 1530.4-2014 criteria

|                     |   |                           |
|---------------------|---|---------------------------|
| Structural Adequacy | - | not applicable            |
| Integrity           | - | no failure at 181 minutes |
| Insulation          | - | 180 minutes               |

and therefore for the purpose of Building Regulations in Australia, achieved a fire-resistance level (FRL) of -/120/120.

The fire-resistance level (FRL) of the specimen is applicable when the system is exposed to fire from either direction. The maximum FRL of any test specimen cannot exceed the FRL achieved by the system in which it was installed. For the purposes of AS 1530.4-2014 the results of these fire tests may be used to directly assess fire hazard, but it should be noted that a single test method will not provide a full assessment of fire hazard under all fire conditions. This certificate is provided for general information only and does not comply with regulatory requirements for evidence of compliance.

Testing Officer: Peter Gordon

Date of Test: 6 July 2020

Issued on the 8<sup>th</sup> day of September 2020 without alterations or additions.

Brett Roddy | Manager, Fire Testing and Assessments

"Copyright CSIRO 2020 ©"

Copying or alteration of this report without written authorisation from CSIRO is forbidden



This document is issued in accordance with NATA's accreditation requirements.  
Accreditation No. 165 – Corporate Site No. 3625  
Accredited for compliance with ISO/IEC 17025 - Testing

**COPY OF CERTIFICATE OF TEST – NO. 3487**



## Certificate of Test

No. 3488

This is to certify that the element of construction described below was tested by CSIRO Infrastructure Technologies in accordance with Australian Standard 1530, Methods for fire tests on building materials, components and structures, Part 4 Fire-resistance tests of elements of construction, 2014, Section 10: Service penetrations and control joints, on behalf of:

IG6 Pty Ltd as trustee for the IG6 IP Trust  
3 Skirmish Court  
Victoria Point Qld 4165

A full description of the test specimen and the complete test results are detailed in the Division's report numbered FSP 2126.

Product Name: SNAP MS70R Multi Services Retrofit fire collars protecting a bundle of 100 Category 5e network cables (Specimen 4)

Description: The specimen comprised an 1150-mm x 1150-mm x 116-mm thick plasterboard wall system penetrated by a service protected by retro-fitted Snap Fire Systems fire collars. The plasterboard wall was constructed in accordance with Boral Firestop system SB120.1 with an established fire resistance level (FRL) of -/120/120 as detailed in the document titled "Plasterboard Fire and Acoustic Systems Australia", revision UB1231-SYS 12/18, by USG Boral Building Products Pty Ltd. The SNAP Multi Service Retrofit MS70R fire collar comprised a 0.75-mm thick steel casing with a 69-mm inner diameter and a 0.95-mm thick steel base flange with a 162-mm diameter as shown in drawing titled "SNAP 70 Multi Service Retro", dated 23 September 2019, by Snap Fire Systems Pty Ltd. One collar was fixed to each side of the wall in a back-to-back configuration through the collar mounting brackets using three M4 expandable steel anchors. The penetrating service comprised a bundle of 100 ADC Krone Category 5e network cables as shown in drawing titled "Specimen #4 100% Full of Cat5e Cables & MS70R Collar", dated 11 June 2020, by Snap Fire Systems Pty Ltd. The cables projected horizontally, 550 mm away from the unexposed face of the wall and approximately 500 mm into the furnace chamber. The cables were supported at nominally 500 mm from the unexposed face of the plasterboard wall.

Performance observed in respect of the following AS 1530.4-2014 criteria

|                     |   |                           |
|---------------------|---|---------------------------|
| Structural Adequacy | - | not applicable            |
| Integrity           | - | no failure at 181 minutes |
| Insulation          | - | 166 minutes               |

and therefore for the purpose of Building Regulations in Australia, achieved a fire-resistance level (FRL) of -/120/120.

The fire-resistance level (FRL) of the specimen is applicable when the system is exposed to fire from either direction. The maximum FRL of any test specimen cannot exceed the FRL achieved by the system in which it was installed. For the purposes of AS 1530.4-2014 the results of these fire tests may be used to directly assess fire hazard, but it should be noted that a single test method will not provide a full assessment of fire hazard under all fire conditions. This certificate is provided for general information only and does not comply with regulatory requirements for evidence of compliance.

Testing Officer: Peter Gordon

Date of Test: 6 July 2020

Issued on the 8<sup>th</sup> day of September 2020 without alterations or additions.

Brett Roddy | Manager, Fire Testing and Assessments

"Copyright CSIRO 2020 ©"

Copying or alteration of this report without written authorisation from CSIRO is forbidden



This document is issued in accordance with NATA's accreditation requirements.  
Accreditation No. 165 – Corporate Site No. 3625  
Accredited for compliance with ISO/IEC 17025 - Testing

**COPY OF CERTIFICATE OF TEST – NO. 3488**



## Certificate of Test

No. 3489

This is to certify that the element of construction described below was tested by CSIRO Infrastructure Technologies in accordance with Australian Standard 1530, Methods for fire tests on building materials, components and structures, Part 4 Fire-resistance tests of elements of construction, 2014, Section 10: Service penetrations and control joints, on behalf of:

IG6 Pty Ltd as trustee for the IG6 IP Trust  
3 Skirmish Court  
Victoria Point Qld 4165

A full description of the test specimen and the complete test results are detailed in the Division's report numbered FSP 2126.

**Product Name:** SNAP MS70R Multi Services Retrofit fire collar protecting a ¾-in and a ½-in Pair Coil, a nominal 25-mm PN12 PVC-U pipe and a 2.5-mm<sup>2</sup> 3C+E power cable (Specimen 5)

**Description:** The specimen comprised an 1150-mm x 1150-mm x 116-mm thick plasterboard wall system penetrated by a service protected by retro-fitted Snap Fire Systems fire collars. The plasterboard wall was constructed in accordance with Boral Firestop system SB120.1 with an established fire resistance level (FRL) of -/120/120 as detailed in the document titled "Plasterboard Fire and Acoustic Systems Australia", revision UB1231-SYS 12/18, by USG Boral Building Products Pty Ltd. The SNAP Multi Service Retrofit MS70R fire collar comprised a 0.75-mm thick steel casing with a 69-mm inner diameter and a 0.95-mm thick steel base flange with a 162-mm diameter as shown in drawing titled "SNAP 70 Multi Service Retro", dated 23 September 2019, by Snap Fire Systems Pty Ltd. One collar was fixed to each side of the wall in a back-to-back configuration through the collar mounting brackets. The penetrating service comprised a ¾-in and a ½-in pair coil, a PN12 PVC-U pipe and a 2.5 mm<sup>2</sup> 3C+E power cable as shown in drawing titled "Specimen #5 ¾-in & ½-in Insulated Copper Pair Coil, 25-mm Pressure PVC, 2.5mm<sup>2</sup> 3C+E Cable & MS70R", dated 11 June 2020, provided by Snap Fire Systems Pty Ltd. The annular gap around the pair coil, PVC pipe, cable and plasterboard on both sides of the wall was filled with a 10-mm deep bead of H.B Fullers Firesound sealant. The 25-mm pressure PVC conduit projected horizontally 2000-mm away from the unexposed face of the wall and approximately 500-mm into the furnace chamber and was supported at nominally 500-mm and 1500-mm from the unexposed face of the wall. The ¾-in and ½-in copper lagged pair coil pipes and the power cable projected horizontally 550-mm away from the unexposed face of the wall and approximately 500-mm into the furnace chamber and were supported at nominally 500-mm from the unexposed face of the wall. The 25-mm pressure PVC pipe was open on the unexposed end and capped with a ceramic fibre (Superwool) plug on the exposed end. The ¾-in and a ½-in copper pipes were left open on the unexposed face and crimped closed on the exposed end.

Performance observed in respect of the following AS 1530.4-2014 criteria

|                     |   |                           |
|---------------------|---|---------------------------|
| Structural Adequacy | - | not applicable            |
| Integrity           | - | no failure at 181 minutes |
| Insulation          | - | 175 minutes               |

and therefore for the purpose of Building Regulations in Australia, achieved a fire-resistance level (FRL) of -/120/120.

The fire-resistance level (FRL) of the specimen is applicable when the system is exposed to fire from either direction. The maximum FRL of any test specimen cannot exceed the FRL achieved by the system in which it was installed. For the purposes of AS 1530.4-2014 the results of these fire tests may be used to directly assess fire hazard, but it should be noted that a single test method will not provide a full assessment of fire hazard under all fire conditions. This certificate is provided for general information only and does not comply with regulatory requirements for evidence of compliance.

Testing Officer: Peter Gordon Date of Test: 6 July 2020

Issued on the 8<sup>th</sup> day of September 2020 without alterations or additions.

Brett Roddy | Manager, Fire Testing and Assessments

"Copyright CSIRO 2020 ©"

Copying or alteration of this report without written authorisation from CSIRO is forbidden



This document is issued in accordance with NATA's accreditation requirements.  
Accreditation No. 165 – Corporate Site No. 3625  
Accredited for compliance with ISO/IEC 17025 - Testing



## Certificate of Test

No. 3490

This is to certify that the element of construction described below was tested by CSIRO Infrastructure Technologies in accordance with Australian Standard 1530, Methods for fire tests on building materials, components and structures, Part 4 Fire-resistance tests of elements of construction, 2014, Section 10: Service penetrations and control joints, on behalf of:

IG6 Pty Ltd as trustee for the IG6 IP Trust  
3 Skirmish Court  
Victoria Point Qld 4165

A full description of the test specimen and the complete test results are detailed in the Division's report numbered FSP 2126.

Product Name: SNAP MS70R Multi Services Retrofit fire collars protecting a bundle of six 16-mm<sup>2</sup> 3C+E and three 6-mm<sup>2</sup> 3C+E power cables (Specimen 6)

Description: The specimen comprised an 1150-mm x 1150-mm x 116-mm thick plasterboard wall system penetrated by a service protected by retro-fitted Snap Fire Systems fire collars. The plasterboard wall was constructed in accordance with Boral Firestop system SB120.1 with an established fire resistance level (FRL) of -/120/120 as detailed in the document titled "Plasterboard Fire and Acoustic Systems Australia", revision UB1231-SYS 12/18, by USG Boral Building Products Pty Ltd. The SNAP Multi Service Retrofit MS70R fire collar comprised a 0.75-mm thick steel casing with a 69-mm inner diameter and a 0.95-mm thick steel base flange with a 162-mm diameter as shown in drawing titled "SNAP 70 Multi Service Retro", dated 23 September 2019, by Snap Fire Systems Pty Ltd. One collar was fixed to each side of the wall in a back-to-back configuration through the collar mounting brackets using three M4 expandable steel anchors. The penetrating service comprised a bundle of six 16-mm<sup>2</sup> 3-core+E power cables and three 6 mm<sup>2</sup> 3-core+E power cables as shown in drawing titled "Specimen #6 16mm<sup>2</sup> 3C+E & 6mm<sup>2</sup> 3C+E Power Cables & MS70R Collar", dated 11 June 2020, by Snap Fire Systems Pty Ltd. The annular gap around the cables and plasterboard on both sides of the wall was filled with a 10 mm deep bead of H.B Fullers Firesound sealant. The cables projected horizontally 550-mm away from the unexposed face of the wall and approximately 500 mm into the furnace chamber. The cables were supported at nominally 500-mm from unexposed face of the plasterboard wall.

Performance observed in respect of the following AS 1530.4-2014 criteria

|                     |   |                           |
|---------------------|---|---------------------------|
| Structural Adequacy | - | not applicable            |
| Integrity           | - | no failure at 181 minutes |
| Insulation          | - | 146 minutes               |

and therefore for the purpose of Building Regulations in Australia, achieved a fire-resistance level (FRL) of -/120/120.

The fire-resistance level (FRL) of the specimen is applicable when the system is exposed to fire from either direction. The maximum FRL of any test specimen cannot exceed the FRL achieved by the system in which it was installed. For the purposes of AS 1530.4-2014 the results of these fire tests may be used to directly assess fire hazard, but it should be noted that a single test method will not provide a full assessment of fire hazard under all fire conditions. This certificate is provided for general information only and does not comply with regulatory requirements for evidence of compliance.

Testing Officer: Peter Gordon Date of Test: 6 July 2020

Issued on the 8<sup>th</sup> day of September 2020 without alterations or additions.

Brett Roddy | Manager, Fire Testing and Assessments

"Copyright CSIRO 2020 ©"

Copying or alteration of this report without written authorisation from CSIRO is forbidden



This document is issued in accordance with NATA's accreditation requirements.  
Accreditation No. 165 – Corporate Site No. 3625  
Accredited for compliance with ISO/IEC 17025 - Testing

**COPY OF CERTIFICATE OF TEST – NO. 3490**

# References

The following informative documents are referred to in this Report:

- |                |  |
|----------------|--|
| AS 1530.4-2014 | Methods for fire tests on building materials, components and structures Part 4: Fire-resistance tests for elements of building construction. |
| AS 4072.1-2005 | Components for the protection of openings in fire-resistant separating elements. Part 1: Service penetrations and control joints.            |



#### CONTACT US

**t** 1300 363 400  
+61 3 9545 2176  
**e** [enquiries@csiro.au](mailto:enquiries@csiro.au)  
**w** [www.csiro.au](http://www.csiro.au)

#### YOUR CSIRO

Australia is founding its future on science and innovation. Its national science agency, CSIRO, is a powerhouse of ideas, technologies and skills for building prosperity, growth, health and sustainability. It serves governments, industries, business and communities across the nation.

#### FOR FURTHER INFORMATION

##### **Infrastructure Technologies**

Brett Roddy  
Team Leader, Fire Testing and Assessments  
**t** +61 2 94905449  
**e** [brett.rodny@csiro.au](mailto:brett.rodny@csiro.au)  
**w** <https://www.csiro.au/en/Do-business/Services/Materials-infrastructure/Fire-safety>